

TECHNICAL MANUAL

**ARMY FACILITIES COMPONENTS SYSTEM  
USER GUIDE**

APPROVED FOR PUBLIC RELEASE; DISTRIBUTION IS UNLIMITED

## REPRODUCTION AUTHORIZATION/RESTRICTIONS

This manual has been prepared by or for the Government and is public property and not subject to copyright.

Reprints or republications of this manual should include a credit substantially as follows: "Department of the Army, USA, TM 5-304, Army Facilities Components System User Guide."

**ARMY FACILITIES COMPONENTS SYSTEM USER GUIDE**

	<i>Paragraph</i>	<i>Page</i>
CHAPTER 1	INTRODUCTION	
	Purpose . . . . .	1-1 1-1
	Scope . . . . .	1-2 1-1
	References . . . . .	1-3 1-1
	Explanation of Abbreviations . . . . .	1-4 1-1
	Background . . . . .	1-5 1-1
	AFCS Publications . . . . .	1-6 1-1
	Comments and Information Sources . . . . .	1-7 1-2
	Inconsistencies, Errors, and Omissions . . . . .	1-8 1-2
	Responsibilities . . . . .	1-9 1-3
	Camouflage and Dispersal . . . . .	1-10 1-3
	Bomb Damage Repair . . . . .	1-11 1-3
CHAPTER 2	AFCS TERMINOLOGY AND DATA	
	AFCS . . . . .	2-1 2-1
	Building Blocks . . . . .	2-2 2-1
	Planning Table . . . . .	2-3 2-1
	Design Criteria . . . . .	2-4 2-1
	Construction Standards and Procurement Considerations . . . . .	2-5 2-2
	Types of Structures . . . . .	2-6 2-2
	Material Waste and Loss . . . . .	2-7 2-2
	Climatic Zones . . . . .	2-8 2-2
	Construction Effort . . . . .	2-9 2-2
	Engineer Unit Capabilities . . . . .	2-10 2-4
	Logistical and Cost Information . . . . .	2-11 2-4
	Operational Conditions . . . . .	2-12 2-4
	Storage and Transit Conditions . . . . .	2-13 2-5

APPROVED FOR PUBLIC RELEASE; DISTRIBUTION IS UNLIMITED

\*This manual supersedes TM 5-304, October 1979

	<i>Paragraph</i>	<i>Page</i>
	Site Orientation . . . . .	2-14 2-5
	Facilities for Initial Period (Up To 6 Months) . . . . .	2-15 2-5
	Facilities for a Temporary Period (Greater Than 6 Months) . . . . .	2-16 2-6
CHAPTER 3	OVERVIEW OF TM 5-301, TM 5-302, TM 5-303, AND THE TACAPS USER GUIDE	
	General . . . . .	3-1 3-1
	Use of TM 5-301 . . . . .	3-2 3-1
	Use of TM 5-302 . . . . .	3-3 3-2
	Use of TM 5-303 . . . . .	3-4 3-3
	TACAPS User Guide . . . . .	3-5 3-3
CHAPTER 4	EXAMPLE PROBLEMS	
	General . . . . .	4-1 4-1
	Multiple Choice Problems (Table Consultation) . . . . .	4-2 4-1
	Simplified Lead-through Problems . . . . .	4-3 4-2
	Using AFCS in Planning and Design . . . . .	4-4 4-6
CHAPTER 5	REQUISITION AND SUPPLY	
	Construction Supplies . . . . .	5-1 5-1
	Requisitioning Procedures . . . . .	5-2 5-1
	Methods of Shipment . . . . .	5-3 5-2
	Foreign Procurement . . . . .	5-4 5-2
	Materials Management . . . . .	5-5 5-2
	Functional Flowchart . . . . .	5-6 5-2
APPENDIX A	REFERENCES	
	Army Regulations . . . . .	A-1 A-1
	Army Supply Catalog . . . . .	A-2 A-1
	Field Manuals . . . . .	A-3 A-1
	Technical Manuals . . . . .	A-4 A-1
	Huntsville Division Manual . . . . .	A-5 A-1
APPENDIX B	CAMOUFLAGE AND DISPERSAL	
	Defensive Measures . . . . .	B-1 B-1
	Camouflage . . . . .	B-2 B-1
	Dispersal . . . . .	B-3 B-2
APPENDIX C	BOMB DAMAGE REPAIR MATRIX . . . . .	C-1

	<i>Paragraph</i>	<i>Page</i>
APPENDIX D	CLIMATIC CONDITIONS	
	Explanation of Climatic Terms . . . . .	D-1 D-1
	Temperate Zone: Intermediate Hot-dry and Intermediate Cold . .	D-2 D-1
	Tropical Zone: Wet-Warm and Wet-Hot . . . . .	D-3 D-4
	Frigid Zone: Cold . . . . .	D-4 D-5
	Desert Zone: Humid-Hot Coastal Desert and Hot-dry . . . . .	D-5 D-5
APPENDIX E	ENGINEERING CAPABILITY TABLES . . . . .	E-1
APPENDIX F	CONSTRUCTION DRAWINGS	
	Purpose . . . . .	F-1 F-1
	Types of Drawings. . . . .	F-2 F-1
	Symbols on Drawings . . . . .	F-3 F-6
APPENDIX G	CPM NETWORK	
	Using CPM . . . . .	G-1 G-1
	CPM Symbols . . . . .	G-2 G-1
	CPM Example . . . . .	G-3 G-3
GLOSSARY . . . . .		Glossary-1

**LIST OF FIGURES**

<i>Figure</i>	<i>Title</i>	<i>Page</i>
2-1	Building orientation . . . . .	2-6
3-1	Example of an installation planning table . . . . .	3-2
3-2	Example of a facility planning table . . . . .	3-3
3-3	Typical TM 5-303 entry . . . . .	3-4
3-4	Example of a TOE . . . . .	3-4
4-1	Procedure for solving lead-through problems . . . . .	4-3
4-2	Components of a 20-by-60-foot building . . . . .	4-6
4-3	AFCS planning and design procedure flow . . . . .	4-7
4-4	Calculations for project duration . . . . .	4-11
5-1	Requisition and supply process . . . . .	5-3
B-1	Dispersal heliport layout . . . . .	B-4
B-2	Heliport layout, friendly air superiority . . . . .	B-5
B-3	Layout, all types of aircraft . . . . .	B-6
B-4	Fixed-wing aircraft layout . . . . .	B-7

<i>Figure</i>	<i>Title</i>	<i>Page</i>
F-1	Typical site plan . . . . .	F-2
F-2	Typical electrical plan . . . . .	F-3
F-3	Elevation views . . . . .	F-4
F-4	Isometric views . . . . .	F-5
F-5	Typical floor plan . . . . .	F-7
F-6	Sectional drawings . . . . .	F-8
F-7	Details . . . . .	F-9
F-8	Light framing details . . . . .	F-10
F-9	Typical wall panels-framing details . . . . .	F-11
F-10	Typical foundation and footing details . . . . .	F-12
G-1	Event numbers . . . . .	G-1
G-2	Circular logic error . . . . .	G-1
G-3	CPM network . . . . .	G-1
G-4	Example CPM diagram . . . . .	G-2
G-5	“Dummy” activity . . . . .	G-2
G-6	CPM diagram for a typical office building . . . . .	G-4

**LIST OF TABLES**

<i>Table</i>	<i>Title</i>	<i>Page</i>
2-1	Extra materials included for waste and loss . . . . .	2-3
2-2	Ranges for operational conditions . . . . .	2-4
2-3	Storage and transit conditions . . . . .	2-5
4-1	Tabulations for example problem 5 . . . . .	4-4
4-2	Tabulations for example problem 7 . . . . .	4-5
4-3	Data for various construction components . . . . .	4-10
D-1	Summary of temperature, solar radiation, and relative humidity extremes . . . . .	D-2
E-1	Equipment assumptions, engineer battalion (combat heavy) . . . . .	E-1
E-2	Engineer unit capability table, engineer battalion (combat heavy) 5-415L . . . . .	E-2
E-3	Engineer unit capability table, headquarters and support company engineer battalion (combat heavy) 5-416L . . . . .	E-3
E-4	Engineer unit capability table, headquarters and support company engineer battalion (combat heavy) 5-417L . . . . .	E-4
E-5	Engineer unit capability table, engineer company pipeline construction 5-434L . . . . .	E-5

---

<i>Table</i>	<i>Title</i>	<i>Page</i>
E-6	Engineer unit capability table, engineer company port construction 5-603L . . .	E-6
E-7	Engineer unit capability table, engineer company dump truck 5-424L . . . . .	E-7
E-8	Engineer unit capability table, engineer company construction support 5-413L . . . . .	E-8
G-1	Construction activities for CPM example . . . . .	G-3
G-2	Tabulation of construction activities . . . . .	G-5

# CHAPTER 1

## INTRODUCTION

---

### 1-1. PURPOSE

The purpose of this manual is to help personnel use the Army Facilities Components System (AFCS) and its products when preparing for and executing Army construction missions in a theater of operations (TO).

### 1-2. SCOPE

This manual is a single-source reference for the operation of AFCS and available AFCS products. Example problems demonstrating the system's use and information about requisition and supply procedures are included.

### 1-3. REFERENCES

Appendix A lists the references cited in this document.

### 1-4. EXPLANATION OF ABBREVIATIONS

Abbreviations and acronyms used in this manual are explained in section I of the glossary. Abbreviations for construction materials are explained in section II of the glossary.

### 1-5. BACKGROUND

*a. Definition.* AFCS is a military engineering construction support system for construction requirements in a TO. AFCS provides data to military planners so that they can prepare contingency plans and support estimates and specific design and logistics information for supplying, constructing, and maintaining facilities in a TO.

*b. The Need for AFCS.* AFCS was designed in response to the vital need for an improved construction planning and supply system. Large inventory errors discovered at the close of World War II were basically caused by the supply system's inadequate inventory capability. During the Korean Conflict, in the absence of a construction planning and supply system, TO planners lacked the resources needed to generate specific projects for base development. Thus, they were forced to use the World War II system of forecasting their needs for across-the-board items of construction material, primarily by reviewing the thousands of items in supply catalogs.

*c. The Development of AFCS.* Since its inception in 1951, AFCS has grown to include planning guidance, detailed construction drawings, and computer updated bills of materials (BOM) for about 3,000 facilities. Some of the facilities included in the system are troop housing, hospitals, bridges, roads, supports, petroleum storage and distribution, and ammunition storage. The system is used:

- For joint, deliberate planning activities (Civil Engineer Support Planning (CESP) development).
- By major Army commands (MACOM's) for theater contingency planning, temporary construction projects, and engineer unit training.
- To support engineer contingency studies.
- To support operational projects.
- To determine contingency Class IV requirements.
- By the U.S. Army Training and Doctrine Command (TRADOC) to support individual training.
- To support Army force development processes.

*d. The Automation of AFCS.* The Theater Army Construction Automated Planning System (TACAPS) was developed in 1985 in order to provide a method for accessing and using current AFCS design and logistics master files in a remote location. TACAPS requires the user to have a microcomputer system for accessing and using AFCS logistics information. TACAPS provides an automated method of identifying, maintaining, and disseminating information for construction planning in a TO or for contingency situations. TACAPS has the unique capability of generating theater facility requirements in terms of either specific AFCS facilities or gross measurement requirements (such as square feet, gallons, etc.) for deployable Army units based on either unit type codes (UTC's) or standard requirement codes (SCR's).

### 1-6. AFCS PUBLICATIONS

AFCS consists of a series of four Department of the Army (DA) technical manuals (TM's). TM 5-304 and its companion manuals, TM 5-301, TM 5-302, and TM 5-303, and the TACAPS User Guide are described briefly



in paragraphs a through d below. Chapter 3 provides detailed instructions for using the manuals.

*a. TM 5-301 Series, Army Facilities Components System - Planning.* The 301 series is generally used by military planners and contains installation, facility, and prepackaged expendable contingency supplies (PECS) summaries. TM 5-301 is published in four volumes: TM 5-301-1, TM 5-301-2, TM 5-301-3, and TM 5-301-4. Each volume addresses a separate climatic zone: temperate, tropical, frigid, and desert, respectively. PECS summaries and facility listings include (1) cost, shipping weight, and volume of material and (2) estimated man-hours needed to construct each facility and installation. The TM 5-301 series may be used by planners at higher levels without referring to TM 5-302 and TM 5-303 (see b and c below). The U.S. Army Engineer Division, Huntsville (USAEDH) maintains current summary information for the facilities and installations listed in the TM 5-301 manuals.

*b. TM 5-302 Series, Army Facilities Components System - Design.* The 302 series is a multivolume manual containing design drawings for installations and facilities; it is of primary interest to the unit actually constructing AFCS facilities in a TO. TM 5-302 is updated when new facilities are added to the system, old ones are deleted, or revisions are made. The designs address the four climatic zones listed in paragraph a above and the two construction standards described in paragraph 2-5 below. The manuals are printed and initially distributed through the U.S. Army Publications and Printing Command.

*c. TM 5-303 Series, Army Facilities Components System - Logistics Data and BOM.* The 303 series is generally used by planners, builders, and supply personnel who need to identify items in the BOM. Each item in a facility (or PECS kit) is identified by a National Stock Number (NSN) and an abbreviated description. The material cost, shipping weight, volume, and estimated construction effort in man-hours are also provided. USAEDH maintains current logistics information for the items in TM 5-303; the information is available in TM 5-303 format.

*d. CEHND 1105-1-1, TACAPS User Guide.* Provided upon request, the TACAPS User Guide is an AFCS specialty document that is not one of the official AFCS TM's; however, it does contain instructions for accessing and using the computerized facility and installation

master files of AFCS information. Chapter 3 provides further information about TACAPS.

## 1-7. COMMENTS AND INFORMATION SOURCES

Data for the manuals are maintained by the U.S. Army Corps of Engineers (USACE). The data in TM 5-301 and TM 5-303 are available by direct computer access via printouts, magnetic tape, or diskette. The drawings in TM 5-302 are half-size (14 by 20 inches) reproducible drawings; those drawings are also available, upon request, in full-size (28 by 40 inches) reproducible or blue-line prints or computer input diskette for computer-aided drafting and design. All correspondence and requests for technical assistance, drawings, and information regarding the AFCS system should be sent to either:

U.S. Army Engineer Division, Huntsville  
ATTN: CEHND-ED-SY  
P.O. Box 1600  
Huntsville, AL 35807-4301

or

HQDA (DAEN-ZCM)  
Washington, DC 20310-2600

AFCS users are encouraged to submit comments and recommendations for improvement or revision directly to HQDA (DAEN-ZCM), Washington, DC. Comments should refer to the specific drawing, facility, or installation. The reason for each comment or recommendation should be stated in order to ensure proper understanding and evaluation.

## 1-8. INCONSISTENCIES, ERRORS, AND OMISSIONS

*a. Design Reviews and Updates.* AFCS is reviewed in order to isolate and correct inconsistencies and incorporate changes in the design drawings and the BOM. Since design work has been carried out over a long period of time, updating and revising are continual.

*b. Facility and Installation Suitability.* Users should carefully study the facilities or installations they propose to acquire, since some facilities or installations might be complete as ordered, while others could require additional or fewer facilities in order to obtain the desired final product.

*c. Cost Data Updates.* Cost data are accurate only at the time of issue. Those data are updated quarterly and can be obtained from USAEDH or accessed by micro-computer in accordance with TACAPS procedures.

## 1-9. RESPONSIBILITIES

USACE continually reviews and updates this manual—a process that includes coordination with DA staff agencies, overseas commands, and other users affected by construction for contingency operations. AR 415-16 details the responsibilities of USACE and other agencies or commands.

## 1-10. CAMOUFLAGE AND DISPERSAL

*a. Camouflage.* Camouflage is the technique of concealing or disguising military activities, materiel, and personnel. It is used to gain the element of surprise and to reduce destruction of equipment and personnel casualties by enemy actions. Camouflage permits the move-

ment and placement of materiel and personnel without detection and gives the impression of being in a position or location that is not really occupied.

*b. Dispersal.* AFCS installation plans use minimum real estate and utilities and are based on functional relationships between facilities. Where dispersal is required because of terrain features or expected enemy actions, additional roads, utilities, and real estate must be added to the plans and constructed.

*c. Further Information.* See appendix B for specific information about using camouflage and dispersal.

## 1-11. BOMB DAMAGE REPAIR

Regardless of how secure a camp may be, the possibility that all or part of a facility could be damaged by enemy actions must be considered. See appendix C for a bomb damage repair matrix of suggestions about repairing typical bomb damages.

## CHAPTER 2

### AFCS TERMINOLOGY AND DATA

#### 2-1. AFCS

AFCS is a system that helps all levels of military planners, supply agency personnel, and construction personnel who have a role in providing temporary Army facilities in support of contingencies.

#### 2-2. BUILDING BLOCKS

AFCS uses a building block concept for maximum flexibility. Items, facilities, subfacilities, installations, and components, explained in paragraph a through e below, make up the building block system:

*a. Item.* An item is any construction material or equipment used to make up a facility. Each item has an associated NSN, description, unit of issue, and quantity. The following are examples of items:

- 5510-00-134-3964 Lumber Softwood Dim 2 Com 2x4x12 BF (Qty)
- 5315-00-164-5126 Nail Common 3d LB (Qty)
- 5530-00-262-8182 Plywood AB Ext 5 Ply 3/4x48x96 in SH (Qty)

Tabulations of AFCS items required for each facility can be found in TM 5-303.

*b. Facility.* A facility is a group of items that provides a service. A facility can also be an item of equipment that enhances a function by providing specific physical assistance. Each facility is assigned and identified by a unique number. The following is an example of a facility description listed in TM 5-301-1:

14185AA Company Headquarters Building,  
600 SF, wood construction, w/concrete floor,  
temperate climate

Each facility has an associated facility number, description, unit of issue, shipping volume, shipping weight, and cost. Several facility numbers may be required to complete a functional facility. For example, constructing a finished and usable barracks building might require:

- (1) The basic building.
- (2) Additional bay (to extend building to some desired length).
- (3) An insulation package.

(4) Electrical lighting and distribution package.

Users, therefore, should carefully read the facility description in TM 5-301 or TM 5-303 so that all necessary components are acquired.

*c. Subfacility.* A subfacility differs from a facility only in its use in TM 5-303 (BOM). A subfacility reduces the repetitive listing of a facility's construction materials. When a facility is used as a subfacility, the entire subfacility is treated as one item of the major facility listed in the BOM. The subfacility's name and a short description of it will appear in lieu of the NSN and shipping/logistics data for each of its items. The subfacility's entire BOM will appear only where it is initially listed as a facility.

*d. Installation.* An installation is a group of facilities designed to provide a specific service or support to a military function in a TO. Installations are listed in the Installation Planning Tables of TM 5-301 and in volume one of TM 5-302. Each installation has a unique associated number (two alpha and four numeric characters). For example:

- NT1131 Troop Camp, 250-man, temperate climate, temporary standard
- DA1061 Ammo Storage, 12,000-ton capacity for temperate climate

The shipping volume, shipping weight, cost, and labor requirements for each installation are also provided.

*e. Component.* Component is a generic term sometimes used to refer to any facility or installation in AFCS. It generally refers to one or more of the system's building blocks.

#### 2-3. PLANNING TABLE

A planning table is a tabulation of installation and facility logistical, cost, and engineering construction data from TM 5-301.

#### 2-4. DESIGN CRITERIA

*a. Site Adaptation.* Design assumptions and criteria, sometimes considered helpful for adapting a structure to specific site conditions, are shown in the working drawings of TM 5-302. Included is information such as maximum

stresses of structural members, assumed concrete strength, minimum soil-bearing capacities, and thermal (climatic) operating range. Those data can be used by qualified personnel to modify the proposed facility if materials or conditions differ from what is listed in the manual.

*b. Safety.* Because of the short design life of the facilities, the minimum safety factors for ensuring personnel and equipment safety during the mission are used. Therefore, AFCS standard designs do not necessarily meet building codes.

## 2-5. CONSTRUCTION STANDARDS AND PROCUREMENT CONSIDERATIONS

Construction standards are based primarily on the length of the contingency operation and are set by the theater commander. The following construction standards conform to Joint Chief of Staff requirements and are included in the facility/installation descriptions printed in TM 5-301:

- Initial (INT) – up to 6 months.
- Temporary (TPR) – up to 24 months.

## 2-6. TYPES OF STRUCTURES

AFCS has two basic types of buildings: disposable and relocatable. Selection is based on mission requirements and resource availability.

*a. Disposable.* Wood frame, block, concrete, or any other material formed at the site and having little or no salvage value.

*b. Relocatable.* Pre-engineered, panelized buildings, or any other structure having 85-percent recoverability.

## 2-7. MATERIAL WASTE AND LOSS

Allowances are made for losses from breakage during handling and waste during cutting and fitting. Table 2-1 lists the percentage of extra materials included.

## 2-8. CLIMATIC ZONES

In order to provide safe, effective, and habitable shelters, all AFCS designs take into consideration the climate of the facility's intended use. AFCS facilities are designed to operate in one or more of four main climatic zones: temperate, tropical, frigid, and desert. Appendix D explains those climatic zones in detail.

## 2-9. CONSTRUCTION EFFORT

The TM 5-301 series gives the estimated construction man-hours required to erect or construct each facility or installation. Those estimates are based on the use of standard construction practices and procedures promulgated by the Engineer School; the estimates do not, however, include administration, mobilization, planning, or work lost by weather delays. The estimates do include the actual construction time required for skilled and unskilled personnel working in and major equipment operated in the temperate zone. Estimates for other climatic zones were obtained with the following adjustment factors:

- Temperate . . . . . 1.00 (base)
- Tropical . . . . . 1.45
- Desert . . . . . 1.25
- Frigid . . . . . 2.41

The various categories of labor that may be involved in a project's construction are described in paragraphs a through c below.

*a. Vertical Labor.* The vertical labor category includes skilled specialties such as:

- Carpenter/mason
- Electrician
- Plumber
- Diver
- Metal worker
- Pipeline specialist

*b. Horizontal Labor.* The horizontal labor category generally includes equipment operators such as:

- Lift/load equipment operator
- Construction equipment operator
- General construction machinery operator
- Dump truck operator
- Concrete/asphalt paving equipment operator
- Quarry machine operator
- Lightweight vehicle/power generator mechanic

*c. General Labor.* The general labor category includes all unskilled workers assisting horizontal or vertical laborers. General laborers perform tasks requiring no prior training or skill or use of mechanical or electrical equipment.

Table 2-1. Extra materials included for waste and loss

Materials	Additional Percent Included in BOM for Waste and Loss
Bolts .....	10
Cement .....	10
Caulking and Curing Compounds .....	10
Electrical:	
Conductor .....	10
Equipment .....	None
Fixtures .....	None
Hardware .....	10
Poles .....	10
Wiring Devices .....	10
Trim .....	10
Glass Substitute .....	10
Lumber:	
Framing .....	15
Sheathing .....	20
Roofing .....	20
Flooring .....	20
Trim .....	10
Form work .....	10
Mechanical Equipment .....	None
Nails:	
Roofing .....	15
All other .....	10*
Paint .....	10
Plumbing:	
Fixtures .....	None
Fittings .....	10
Pipe .....	20
Pipe Insulation .....	10
Rivets .....	10
Roll Roofing .....	20
Steel:	
Structural Shapes .....	None
Sheet Metal .....	10
Sewers and Drains:	
Concrete Pipe .....	20
Fiber Pipe .....	05
Welding Rod .....	100

\*Reported experience with troops and troop construction indicates a need for more than a 10-percent wastage factor for nails.

Table 2-2. Ranges for operational conditions

	Air Temperature °F	Ambient Conditions Relative Humidity %	Solar Radiation Btu/ft <sup>2</sup> /hr
<b>Temperate Zone:</b>			
Intermediate Hot Dry	70 to 110	20 to 85	0 to 360
Intermediate Cold	-5 to -25	tending toward saturation	negligible
<b>Tropical Zone:</b>			
Wet Warm	75	95 to 100	negligible
Wet Hot	78 to 95	74 to 100	0 to 360
<b>Frigid Zone:</b>			
Cold	-35 to 50	tending toward saturation	negligible
<b>Desert Zone:</b>			
Humid Hot Coastal Desert	85 to 100	63 to 90	0 to 360
Hot Dry	90 to 125	5 to 20	0 to 360

## 2-10. ENGINEER UNIT CAPABILITIES

*a. Derivation of Productivity.* Through the use of DA guidance, the productive capabilities of various engineer units have been estimated in terms of man-hours per month. The productive capabilities of various engineer units (summarized in appendix E) were derived by (1) deducting the nonproductive units from the overall number of units for administrative, maintenance, mess, communication, and medical personnel and operators of administrative vehicles and (2) degrading the overall unit numbers by enemy actions and movement factors as shown in AR 570-2. The work period for all units is 10 hours per day, 7 days per week, 365 days per year. The functional skill groups listed in appendix E should not be interpreted as the sum total of skills available in the unit, but only as an indicator of unit capabilities. For more details on mission, assignment, and capabilities of each engineer unit, refer to FM 101-10-2.

*b. Reduced Productivity.* The productive capabilities indicated in paragraph a above do not take into consideration several other aspects of unit capabilities. Additional reductions in the productive capabilities of engineer units can result from equipment processing following debarkation, area orientation, job organization, and acclimation of troops because of a change in climate and significant changes in altitude. As a conservative guide, productivity should decrease by 70 percent during the first 15 days when acclimation, equipment processing, area orientation, and job orientation are involved. When acclimation is not a factor, productivity should decrease by only 50 percent during the first 15 days.

## 2-11. LOGISTICAL AND COST INFORMATION

*a.* The material cost data and logistical data shown in TM 5-303 (BOM) are current as of the date of publication. Transportation costs for shipment are not included.

*b.* The user must be careful when unpacking materials and equipment. The user should check for missing materials immediately so that requisition procedures can be started, if necessary. Also, since the length of certain structural members is critical, components such as columns and certain roof truss pieces and roof and floor joists should be set aside in order to ensure that they are not cut up for use as smaller pieces. The user should also ensure that packing materials are removed carefully and not damaged, since those materials may be items (such as furring strips, etc.) needed for construction.

*c.* Aggregates for concrete cannot be requisitioned from TM 5-303 (BOM). AFCS logistics data is based on the assumption that aggregates will be available within 5 miles of the construction site and can be acquired locally. Construction planners should ensure that necessary aggregates are available when the site is known.

## 2-12. OPERATIONAL CONDITIONS

Operational conditions are the climatic conditions to which personnel and materials may be subjected during military operations. Operational conditions are stated in terms of ambient temperature and humidity under standard conditions of ventilation and radiation shielding. Table 2-2 lists the ranges of operational conditions for

Table 2-3. Storage and transit conditions

	Induced Air Temperature °F	Induced Relative Humidity %
<b>Temperate Zone:</b>		
Intermediate Hot Dry	70 to 145	5 to 50
Intermediate Cold	-10 to -30	tending toward saturation
<b>Tropical Zone:</b>		
Wet Warm	80	95 to 100
Wet Hot	90 to 160	10 to 85
<b>Frigid Zone:</b>		
Cold	-35 to -50	tending toward saturation
<b>Desert Zone:</b>		
Humid Hot Coastal Desert	90 to 160	10 to 85
Hot Dry	90 to 160	2 to 50

each climatic region. The temperature of any type of material may vary considerably from the operational temperature because of the effects of solar radiation, shading, internal heat sources, thermal mass, and heat-transfer characteristics.

### 2-13. STORAGE AND TRANSIT CONDITIONS

Storage and transit conditions are the air temperature and humidity conditions to which material may be subjected during storage and transit (such as inside a military-owned demountable container (MILVAN) or unventilated field storage shelter, under a tarpaulin, in a tent, or in a railway boxcar). Table 2-3 gives the estimated ranges of the induced temperature and humidity for each climatic region. Construction materials and equipment used in AFCS must be protected from prolonged exposure to adverse conditions.

### 2-14. SITE ORIENTATION

*a. Climatic Factors.* Building orientation can take advantage of natural attributes, such as solar heat gain (or shading), prevailing breezes for cooling, and placement of buildings on slopes facing the equator for added warmth in cold climates. Figure 2-1 demonstrates the passive use of climatic factors.

*b. Site Adaptation.* Generally, AFCS installation plans assume a flat site; flat sites, however, rarely occur in the field. Therefore, it is necessary to perform a site analysis that considers factors such as slope, drainage, existing vegetation, access to and from the site, dispersal,

camouflage, and climate. AFCS utility design and the BOM are based on a specific layout on a flat site. Actual utility design must be based on actual site conditions with the BOM adjusted accordingly. Since the installation layouts provided are based on ideal conditions, the user must revise the layout, as required, based on the site analysis.

### 2-15. FACILITIES FOR INITIAL PERIOD (UP TO 6 MONTHS)

*a.* Facilities should be only those austere, quickly erectable, mission-essential facilities required to support the troops and their equipment.

*b.* Studies reveal that very few common construction items will be acquired and delivered within the initial 6-month period of a contingency operation. Therefore, construction material critical to mission success should be stockpiled by the appropriate MACOM and should be air-transportable or pre-positioned. Pre-positioning and local theater procurement are normally the best ways to ensure that materials are available when needed because high-priority logistics requirements for mission material and personnel are in effect early.

*c.* Operational planners for initial facilities should ensure that (1) the facility list includes only critical facilities, (2) air or sea transport will be made available, and (3) procurement, production lead time, and transport and erection time are adequate to support the operation plan. Normally, organic equipment and facilities and Common Table of Allowances (CTA) equipment and facilities should not be duplicated by AFCS facilities.

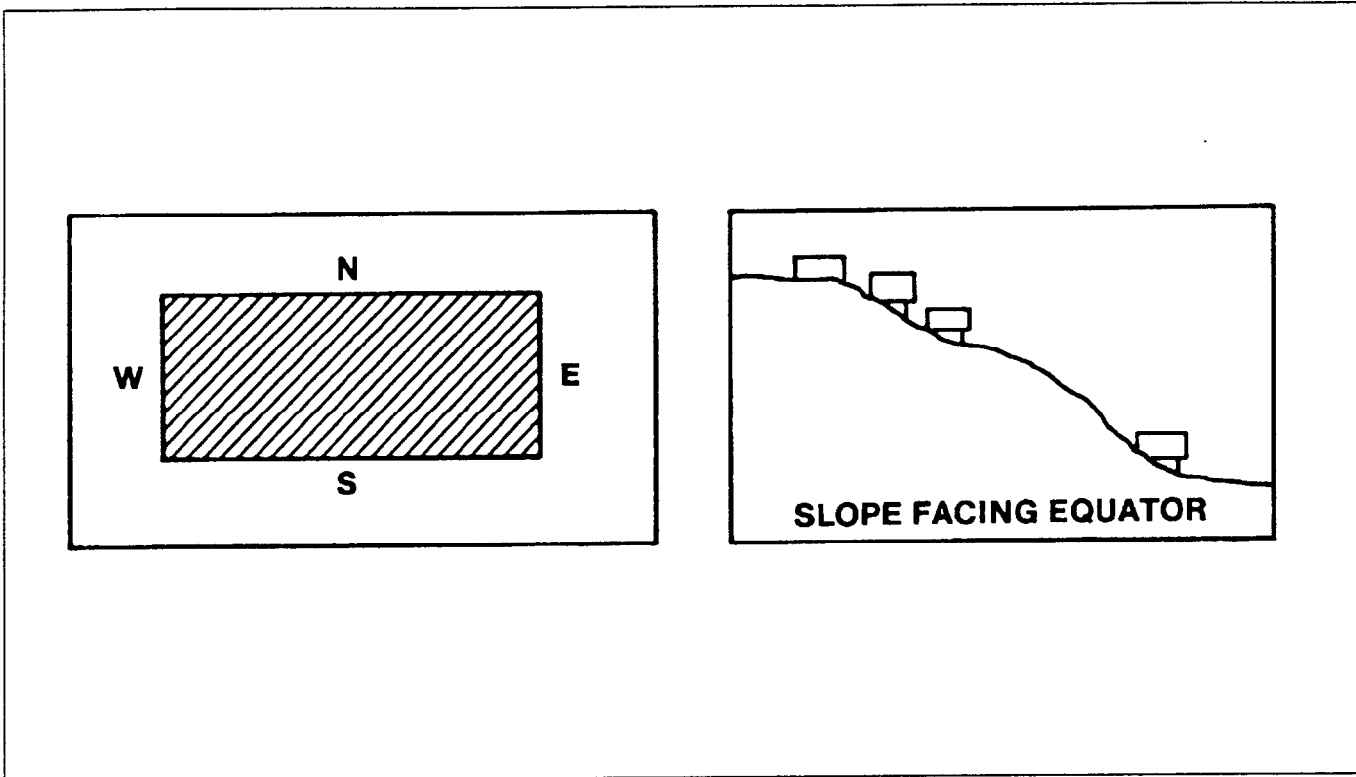

Figure 2-1. Building orientation

d. If delivered first or pre-positioned, temporary relocatable buildings could be erected and used to protect initial and temporary materials, thereby increasing their in-theater life.

## 2-16. FACILITIES FOR A TEMPORARY PERIOD (GREATER THAN 6 MONTHS)

a. Temporary standards should provide a wider selection of minimum facilities, thereby increasing the efficiency, safety, durability, morale, and health standards of personnel on operations. Temporary standards are normally considered most appropriate in a secure Com-Z area.

b. For local theater acquisition, the theater commander and logisticians should see what is available locally in the priority listed in (1) through (4) below:

(1) Using AFCS plans and the BOM, determine if materials are locally available or adapt AFCS designs to conform to the local building system.

(2) Use local off-the-shelf materials after determining compatibility with organic, CTA equipment or other continental United States (CONUS) components.

(3) Use local materials that can be acquired or manufactured quickly.

(4) Use semipermanent approaches, such as lumber, brick, block, etc., that are common in the local area; also, use nationals skilled in working with the type of construction materials chosen.

c. For CONUS acquisition, the Standard Army supply systems should be used when any of the conditions in paragraphs (1) through (4) below exist:

(1) Needed materials are not available locally or supply is not dependable.

(2) Local economy lead times are in excess of Army Materiel Command (AMC) acquisition and delivery times.

(3) Local materials are not compatible with mission equipment or requirements, i.e., 50-cycle electrical power versus 60-cycle electrical fixtures and material.

(4) Pre-positioning or the early execution of an operational project will satisfy all requirements for necessary construction materials in a timely manner.



## CHAPTER 3

### OVERVIEW OF TM 5-301, TM 5-302, TM 5-303, AND THE TACAPS USER GUIDE

#### 3-1. GENERAL

This chapter explains the purpose and content of each of the AFCS manuals. Also, for those who are not engineers, a brief section is included on the use of construction drawings. Furthermore, since some new and typical AFCS designs will contain a critical path method (CPM) network, a brief section describing CPM and how it can be used to control actual construction is provided.

#### 3-2. USE OF TM 5-301

*a. Purpose.* TM 5-301 is a planning document that provides material costs and logistical and engineering data needed to plan theater construction. TM 5-301 is intended for use by those listed in paragraphs (1) through (3) below:

(1) Contingency, base development, construction, and logistical planners.

(2) Construction units (since the manual contains the engineering data required for construction of the various structures, facilities, installations, and utilities required by the Army and Air Force for the support of military missions in the theater).

(3) Logistical commands and supply agencies for requisitioning, identifying, costing, and other related supply functions.

*b. Installation Planning Tables.* The term "planning tables" describes data published in TM 5-301 under the category of installations or facilities. (See figure 3-1 for an example of an installation planning table.) Installations are shown in the ascending order by the installation number in the upper right-hand corner, which consists of two alpha and four numeric characters (such as AR1511). The number identifies the complete BOM required to construct that installation. The installation description appears in the upper left-hand corner and includes the title, standard and type of construction, purpose, and other information as needed. The tables contain the items listed in paragraphs (1) through (9) below, which coordinate with the circled numbers in figure 3-1:

(1) *Drawing Number.* TM 5-302, volume 1, contains the installation drawings, which are listed in the alphanumeric sequence by installation numbers.

(2) *Facility Number.* Five numeric and two alpha characters identifying each AFCS facility (such as 21410BW). The five numeric characters are the construction category codes from AR 415-28.

(3) *Facility Description.* A brief description of the facilities included in the installation.

(4) *Size or Unit.* Dimensions, capacity, or unit of measure for each installation facility.

(5) *Basis.* The criteria or standard planning basis on which facilities are included in the installation.

(6) *Quantity Required.* The quantity needed of a particular installation facility.

(7) *Materials.* The total materials, logistics, and cost data associated with the number of facilities. Weight is shown in short tons (ST) (2,000 pounds) and volume in measured tons (MT) (40 cubic feet per measured ton).

(8) *Construction Man-Hours.* The estimated horizontal, vertical, and general construction man-hours.

(9) *Installation Totals.* The materials, logistics, and cost data and the construction effort totals shown at the end of each table. (Note that costs listed are current only at the time of publication.)

*c. Facility Planning Tables.* Another feature of TM 5-301 is the facility planning tables (see figure 3-2 for an example). AFCS facilities are identified by their application in a TO. The tables contain the items listed in paragraphs (1) through (4) below, which coordinate with the circled numbers in figure 3-2:

(1) *Facility Number.* Five numeric and two alpha characters that identify each facility (such as 41180AG). The TM 5-302 numbering system uses the entire facility number for the corresponding construction drawing; however, there is not a drawing for every facility number.

(2) *Description.* A detailed description of each facility. TM 5-303 provides a detailed BOM for each facility; TM 5-302 provides construction drawings and drawings for utilities (electric, sewage, and water).

TM 5-301

TROPIC CLIMATE

Vehicle maintenance installation for all levels of support through general support activities. Consist of 20 bays and shop area for off vehicle repair. Temporary standard in the tropic/desert climates, wood buildings. MT2028

FAC NUMBER	FACILITY DESCRIPTION	SIZE OR UNIT	BASIS	QUANTITY REQUIRED	MATERIALS			CONSTR EFFORT IN MAN-HOURS				
					WT-ST	VOL-MT	COST	HORZ	VERT	GENL	TOT	
21410BW	TRACKED VEH TURNING PAD		AS REQUIRED	31.4	828	471	41197					
21410BY	VEH WASH RACK		6 PER INST	6.0	126	90	9588	35	513	713	1261	
21410GT	3600 SQ FT BUILDING GT WOOD		2 PER INST	2.0	2030	1762	151154	1073	8555	2790	12418	
21410HN	VEHICLE MAINT FAC WD FR 6 BAY T/D		2 PER INST	2.0	2610	2234	183256	1154	9918	3109	14181	
21411AA	LUB RACK, VEHICLE, 12X56 RAMP + PLATED		4 PER INST	4.0	28	20	3460		2088	348	2436	
72321BD	LAT PIT TYPE 180-MAN 8-SEAT 10X20	10X20X8	1 PER INST	1.0	8	9	1559	3	290	46	339	
81240HB	ELECTRICAL DISTRIBUTION SYS 250-MAN		AS REQUIRED	1.0	28	42	27991	3	33	3	39	
84120FA	ELECTRICAL DISTRIBUTION SYS 250-MAN		AS REQUIRED	1.0	28	42	27991	3	33	3	39	
84330AC	SUMP FIRE PROTECTION 10000 GAL	10000 GAL	AS REQUIRED	1.0	7	5	145	23	157	168	348	
84330AE	FIREFHT EQPT POL W/10MGAL WTR&PUMP		AS REQUIRED	1.0	1	5	16777		49		49	
85110DF	HARDSTAND, STAB SURF, 1000 SQ YD, 4 IN		AS REQUIRED	36.0	1512	1008	7560	1253		418	1871	
187190AA	SITE PREPARATION, 1 ACRE		AS REQUIRED	8.3				1059		385	1444	
87210AA	FENCE, CHAINLINK W/2 OUTGRS 1	1000LF	AS REQUIRED	2.5	43	128	30185	453		1450	1903	
87210AF	GATE, CHAINLINK SING/LEAF 3 WI 10 HI		AS REQUIRED	1.0	1	2	279	9		17	26	
87210AL	GATE, VEH CHAINLINK 10 FT HI 32 F WI		AS REQUIRED	1.0	1	2	401	10		22	32	
					7051	5820	501543	5078	23047	11612	39737	

Figure 3-1. Example of an installation planning table

(3) **Construction Material.** The logistics and cost data associated with each facility. The weight, given in short tons (2,000 pounds) includes packing material. The shipping volume is given in measured tons (40 cubic feet per measured ton). Costs are current as of the date of issue and are based on the Stock Item Master File (SIMF).

(4) **Construction Effort in Man-Hours.** A list of the estimated engineer effort for horizontal, vertical, and general skills. The "total" column represents the sum of those items.

### 3-3. USE OF TM 5-302

a. **General.** TM 5-302 provides construction drawings to be used by military units in a TO. TM 5-302 contains installation layouts, facility plans, construction details, and lists of materials. The drawings consist of standard architectural/engineering working drawing elements. TM 5-302 is intended for use by:

(1) Base development planners determining facilities required to support Army functions.

(2) Engineer commands or units preparing and issuing construction drawings.

(3) Construction personnel acquiring materials and doing the actual construction.

(4) Supply personnel identifying and supplying construction materials.

b. **Construction Drawings.** Appendix F briefly describes how to use the construction drawings.

c. **CPM Networks.**

(1) Network analysis is a method of planning and controlling projects by recording the interdependence of operations in a diagrammatic form so that each basic problem can be solved separately. Some important advantages of network analysis are listed in paragraphs (a) through (d) below:

(a) Network analysis shows the interdependencies between jobs, and enables people to see the overall plan and how their own activities depend on or influence the activities of others. Setting out the complete plan for everyone involved in the project makes assessment easier and helps prevent unrealistic or superficial planning.

TEMPERATE CLIMATE <sup>1</sup>		TM-5-301 <sup>3</sup>			CONSTRUCTION EFFORT IN MAN-HOURS <sup>4</sup>			
FACILITY NUMBER	DESCRIPTION <sup>2</sup>	WT SHT TONS	VOL MEAS TONS	COST \$	HOR	VERT	GENL	TOT
41180AG	TANK, POL, 3000 BARREL, W/6 IN PIPE + FITTINGS TO TANK BERM + BERM DRAIN ASSEMBLY	2	32	12,392	90	310	210	61
41180AH	TANK, POL, 3000 BARREL, W/8 IN PIPE + FITTINGS TO TANK BERM + BERM DRAIN ASSEMBLY	2	32	12,044	90	310	220	62
41180AJ	TANK, POL, 10000 BARREL, W/6 IN PIPE + FITTINGS TO TANK BERM + BERM DRAIN ASSEMBLY	2	40	20,700	140	850	420	1,41
41180AK	TANK, POL, 10000 BARREL, W/8 IN PIPE + FITTINGS TO TANK BERM + BERM DRAIN ASSEMBLY	3	40	20,115	140	850	430	1.42
41180AL	TANK, POL, 10000 BARREL, W/12 IN PIPE + FITTINGS TO TANK BERM + BERM DRAIN ASSEMBLY	3	40	26,397	145	850	435	1,43
41180AM	TANK, POL, 50000 BARREL, W/8 IN PIPE + FITTINGS TO TANK BERM + BERM DRAIN ASSEMBLY	4	193	52,847	300	4,430	2,000	6,74
41180AN	TANK, POL, 50000 BARREL, W/12 IN PIPE + FITTINGS TO TANK BERM + BERM DRAIN ASSEMBLY	4	193	60,934	300	4,440	2,000	6,74

Figure 3-2. Example of a facility planning table

(b) Resource and time constraints can be included in the plan before its evaluation. An example of a resource constraint would be several operations requiring a crane, but only one crane is available. An example of a time constraint would be a minimum delivery period for materials (such as long lead-time items).

(c) Stricter controls can be used, since any deviation from the schedule is noticed quickly.

(d) If the completion date must be advanced, attention can be concentrated on speeding up only the few critical jobs. Then resources are not wasted on speeding up noncritical jobs.

(2) Appendix G explains specific steps and details for developing and using CPM networks.

### 3-4. USE OF TM 5-303

TM 5-303 is generally used by planners, builders, and suppliers in order to identify facility construction materials. A portion of a typical page in TM 5-303 (see figure 3-3) contains the information listed in paragraphs a through i below, which coordinate with the circled letters in figure 3-3:

a. *Facility Number.* Five numeric and two alpha characters that identify each AFCS facility (e.g., 54010AW).

b. *Building Description.* Information about frame type, roofing and siding material, climatic zone, and dimensions.

c. *Man-Hours.* Construction estimate in vertical, general, and horizontal construction in terms of man-hours.

d. *Materials.* Logistical data, including shipping weight, volume, and costs.

e. *BOM Section.* Structural component breakdown.

f. *NSN.* A unique number, assigned by the Department of Defense (DOD), that identifies the item.

g. *Item Description.* A general description of an item.

h. *Unit of Issue.* The smallest quantity per issue, such as each, linear foot, pound, package, etc. (See section II of the glossary for abbreviations.)

i. *Quantity.* Amount of material required to construct the facility, including allowance for breakage, loss, and cutting to fit.

### 3-5. TACAPS USER GUIDE

a. The TACAPS User Guide explains how to use TACAPS effectively. The Huntsville Division TACAPS point of contact will provide system diskettes and specific user information upon request.

b. The user can install TACAPS on a personal computer by following the instructions provided with the diskettes and the specific user information contained in the TACAPS User Guide. User-friendly menus help the user access the facility and installation files in order to get current TM 5-301 and TM 5-303 information and use the tables of organization and equipment (TOE's)/facility base-camp planning module. Figure 3-4 shows an example of a TOE/facility computation.

c. The TOE/facility module enables the planner to develop specific base camps that are tailored to TOE organization requirements. The facility makeup for a

		FACILITY 12510BE ← (A)			
		PIPELINE, POL, 5 MILES OF 6 INCH GROOVED LT WT TUBING, W/COUPLINGS 500 FT API BEVELED PIPE, 5 GATE & 1 CHECK VALVE			
(C)	MAN-HOURS	HOR 50	VER 1450	GEN 1100	TOT 2600
(D)	MATERIALS	SHT TONS 147	MEAS TONS 239	CST\$ 158,943	
		SEC 12 MISC EQUIPMENT AND FUEL SYSTEMS			
(E)	3439-00-262-2671	ELECTRODE WELDING 1/8" F/STEEL	(G)	LB	50.0
(F)	3439-00-262-2678	ELECTRODE WELDING 5/32"X14"LG		LB	100.0
	3835-00-641-7487	VALVE SECTION CHECK 6 INCH CLAS 250		EA	1.0
	3835-00-641-7488	VALVE SECTION GTE 500PSI 60INX3FT LG		EA	5.0
	3835-00-693-4508	VALVE ASSEMBLY PRESSUR RELIEF 1/2IN		EA	1.0
	4710-00-202-6755	PIPE STEEL 6INX17-22FT R/L BEV ENDS		FT	500.0
	4710-00-203-0183	TUBE STEEL 6.625X 20FT GROOVED ENDS		LG	1456.0
	4710-00-273-1042	PIPE CULV NEST STL 2SECT 1.5X25.5IN		EA	80.0
	4730-00-202-6739	CLAMP LEAK RPR PIPE CPL 6 INCH NOM SZE		EA	10.0
	4730-00-222-3739	CLAMP REPAIR PIPE STEEL 6 INCH X 12		EA	10.0
	4730-00-278-2669	COUPLING PPE STL 6INX6IN LG UNTHD		EA	24.0
	4730-00-288-9514	CLAMP COUPLING FOR 6IN GROOVED PIPE		EA	1498.0
	5306-00-257-4224	BOLT OVAL,,750-10UNC,4.50IN		EA	100.0
	5330-00-141-4225	PACKING PREFORMED SYN RUBBER		EA	75.0

Figure 3-3. Typical TM 5-303 entry

BASE-CAMP CAMPX	TOTAL ENLISTED 00217	TOTAL OFFICER 00017			
07178H010	CSC, INF BN, LT INF BDE	00104	00005		
08147H000	MED CO, SEP AIM BDE, ACR	00113	00012		
FACILITY	QUANTITY REQUIRED	RATE	QUANTITY ASSIGNED	INST CODE	UNIT OF MEASURE
COMPANY HQS BUILDING 14185	044249	07	00800	111	SQFT
COMM/ELECT MAINT SHOP 21710	000410	01	01000	111	SQFT
COLD STORAGE (UNIT) 43210	000108	02	00150	111	CUFT
COVERED STORAGE (UNIT) 44220	000006	02	00600	111	CUFT
TROOP HOUSING, ENLISTED 7211	015624	08	01872	111	SQFT

Figure 3-4. Example of a TOE

developed base camp is determined via computer by using DOD criteria for each construction category code (AR 415-16) and the personnel/equipment makeup of the selected TOE organizations as identified in the approved TOE master files. The computer results include equipment line item numbers, military occupational specialty numbers, and enlisted personnel and officer head count. The planner simply enters into the com-

puter the standard requirements code or unit code and the quantities for all planned TOE units. All requirements are integrated into a single camp plan, and the camp list of quantities required at specific AFCS facilities can then be generated. The planner has the option of deleting, adding, or changing any facility on the list and producing the TM 5-301 or TM 5-303 items for the developed camp facilities.

## CHAPTER 4

### EXAMPLE PROBLEMS

#### 4-1. GENERAL

Several example problems have been developed in order to demonstrate the use of AFCS for military planning, design, etc. The problems range from simple data extraction from the various manuals to a complex planning problem. Since AFCS is an extensive system with a broad range of facility types, it is not possible to cover all available facilities; however, the general procedures for using the system are the same for all facility types. Therefore, the example problems in this chapter should provide adequate guidance.<sup>1</sup>

#### 4-2. MULTIPLE CHOICE PROBLEMS (TABLE CONSULTATION)

The purpose of these problems is to (1) familiarize the user with the AFCS installation and facility numbering systems and (2) teach the user how to extract component data from the various manuals. The problems demonstrate how facilities and installations can be combined to meet any desired function; they also show the user how to select the components that best meet a function's requirements.

*a. Example problem 1.*

(1) *Problem Statement.* A troop camp must house 1,700 military personnel in the temperate zone (temporary standard of construction). Which of the combinations of installations listed in (a) through (c) below will meet that requirement for the least cost? What will be the estimated construction effort required?

- (a) Two NT1531
- (b) One NT1531 and two NT1231
- (c) One NT1531 and three NT1131

(2) *Solution.* Determine the cost of each installation from data in TM 5-301-1. (Note that shipping costs, the costs of hiring civilian labor, etc., are not included.) Also, verify the capacity of the cantonment.

- (a) If one NT1531 costs \$516,813, then:  
 $\$516,813 \times 2 = \$1,033,626$  for 2,000 personnel

(b) If one NT1531 costs \$516,813 and one NT1231 costs \$44,242, then:

$$\$516,813 + 2(\$44,242) = \$605,297 \text{ for 1,750 personnel}$$

(c) If one NT1531 costs \$516,813 and one NT1131 costs \$71,271, then:

$$\$516,813 + 3(\$71,271) = \$730,626 \text{ for 1,750 personnel}$$

Although all of the installations can meet the 1,700-person capacity requirement, choice (b) is the least expensive. The estimated construction effort for this combination would be:

Construction Effort in Man-Hours				
Installation	Horizontal	Vertical	General	Total
NT1531	19,603	14,310	11,192	45,105
NT1231 (2)	4,428	3,892	3,314	11,634
Total	24,031	18,202	14,506	56,739

*b. Example Problem 2.*

(1) *Problem Statement.* A hospital having at least a 700-bed capacity is required in the temperate zone (initial standard of construction). Which of the installations or combinations of installations listed in (a) through (c) below can meet that requirement with the least effort?

- (a) One GH0521 and two GH0121
- (b) One GH0521 and one GH0221
- (c) One GH0721

(2) *Solution.* Obtain cost information from the installation section of TM 5-301-1. Also, verify the hospital's required capacity. Calculate the man-hours (MH's) in order to find the least construction effort.

(a) If one GH0521 (500 beds) takes 28,021 MH and GH0221 (100 beds) takes 14,184 MH, then:

$$28,021 \text{ MH} + 2(14,184 \text{ MH}) = 56,389 \text{ MH for 700 beds}$$

(b) If one GH0521 (500 beds) takes 28,021 MH and one GH0221 (200 beds) takes 14,483 MH, then:

$$28,021 \text{ MH} + 14,483 \text{ MH} = 42,504 \text{ MH for 700 beds}$$

1. Costs and man-hours used in the examples may not be current but are valid for comparison purposes.

(c) If GH0721 (750 beds) takes 33,431 MH, then it meets the 700-bed requirement and uses the least construction effort.

*c. Example Problem 3.*

(1) *Problem Statement.* Which installation listed in (a) through (d) below would be a suitable PECS installation for use with general construction and renovation?

- (a) YY1009
- (b) YY1029
- (c) YY1049
- (d) YY1059

(2) *Solution.* Refer in TM 5-301-1 to the installation description for each installation number listed in (a) through (d) above. YY1029 is the only one that indicates use with general construction and renovation work.

*d. Example Problem 4.*

(1) *Problem Statement.* A 6,600-square-foot area of warehouse space is required in a materiel receiving area. For a wood frame building, which of the combinations of warehouses listed in (a) through (d) below would best satisfy the storage area requirement?

- (a) Three 44220DA and one 44220BA
- (b) Six 44220CA and one 44220BA
- (c) One 44220EA, one 44220DA, and one 44220BA
- (d) Five 44220CA and one 44220DA

(2) *Solution.* The information needed for tabulating the square footage of each facility has been taken from TM 5-301-1. Therefore, if:

- 44220BA is 600 square feet
- 44220CA is 1,000 square feet
- 44220DA is 2,000 square feet
- 44220EA is 4,000 square feet

then:

- (a)  $3(2,000) + 1(600) = 6,600$  sq ft
- (b)  $6(1,000) + 1(600) = 6,600$  sq ft
- (c)  $1(4,000) + 1(2,000) + 1(600) = 6,600$  sq ft
- (d)  $5(1,000) + 1(2,000) = 7,000$  sq ft

Answers (a), (b), or (c) appear to be valid choices if considering only square footage, since they meet, but do not substantially exceed, the 6,600 square foot requirement.

However, a complete analysis would also consider procurement and shipping costs as well as the construction effort in man-hours, making (c) the most practical choice.

### 4-3. SIMPLIFIED LEAD-THROUGH PROBLEMS

These problems show the user how to compile a list of facilities or installations in order to meet certain functional requirements. Figure 4-1 shows a flowchart of the general procedure.

*a. Example Problem 5.* Construct a 300-bed hospital for use in a temperate climate (wood frame, temporary construction standard). Also, provide an electrical power generator (208/120 V, 60 Hz) and a generator building, as necessary. No existing facility can be used to fulfill any part of the requirements. The solution procedure is described in paragraphs (1) through (8) below:

(1) *Step 1.* Identify the climatic zone. Use TM 5-301-1, since the facility will be in the temperate zone.

(2) *Step 2.* Determine whether to look for the data under the Listing of Installations or under the Listing of Facilities. An installation is a group of facilities designed to provide a specific service. A hospital, therefore, would be an installation because it is made up of facilities such as an administration building, surgery buildings, laboratories, staff housing, recreation buildings, a water distribution system, and electrical distribution. If you do not know how to determine whether a unit is an installation or a facility, it is easiest to consult the Listing of Installations first and then the Listing of Facilities.

(3) *Step 3.* Check the index of the Listing of Installations in TM 5-301-1 for temperate climates. Locate the page where "Hospital" begins. Review each hospital installation until the required size, standard of construction, and type of construction is found. The best choice appears to be GH0361. Beneath the description of the installation is a list of its numbered facilities. Become familiar with all information on the page. When GH0361 is ordered, all of the facilities listed will be supplied. Also note the shipping and construction effort information, which can be of great value to the planner. For example, the utilities provisions are given: 15,000 gallons of water per day, 10,500 gallons of sewage per day, and 1,203 kW electrical power.

(4) *Step 4.* Check whether the final product will require additional facilities or installations. For example,

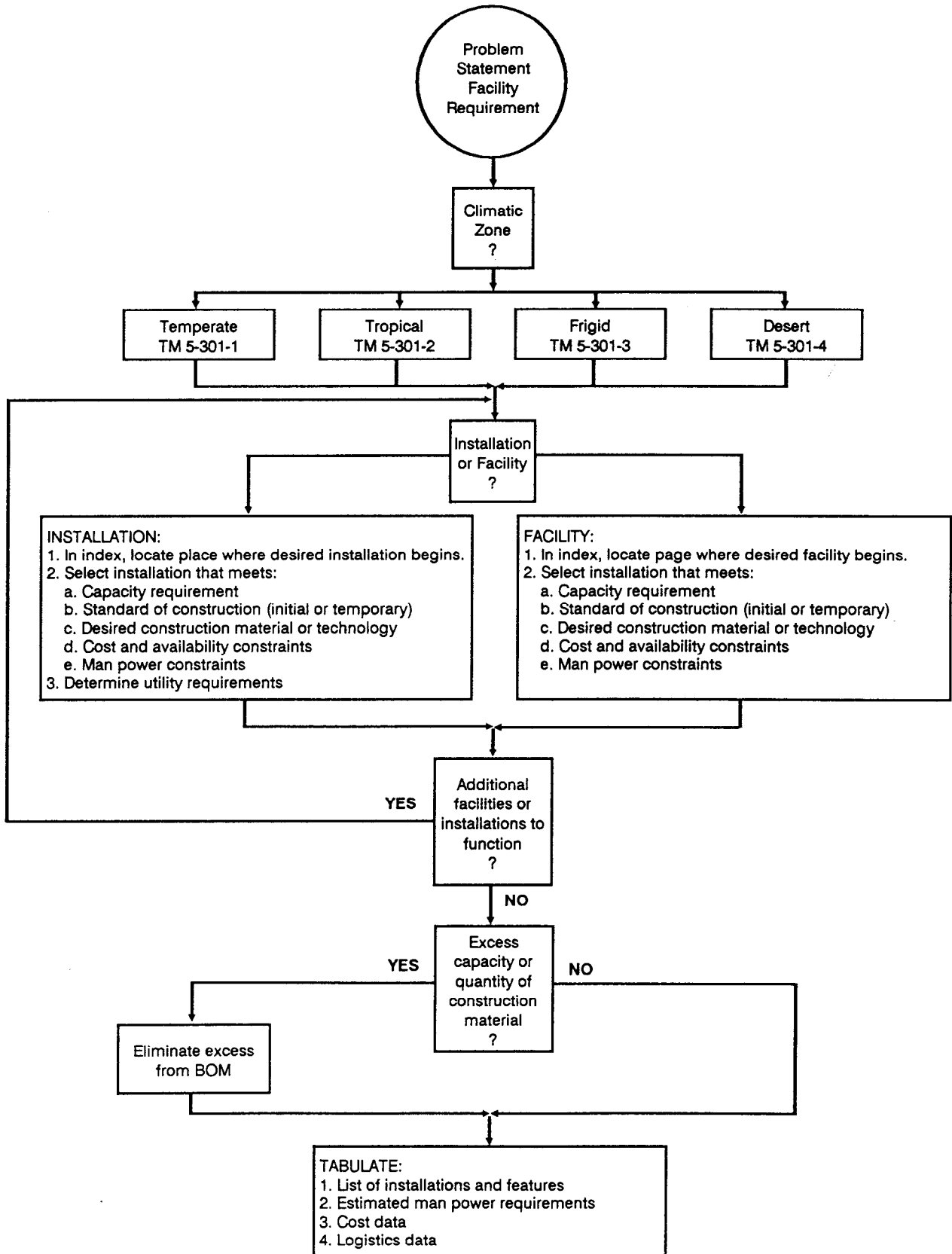

Figure 4-1. Procedure for solving lead-through problems

Table 4-1. Tabulations for example problem 5

	Quantity	Materials			Construction Effort in Man-Hours			
		Weight short tons	Volume measured tons	Cost \$	Horizontal	Vertical	General	Total
GH0361	1	2,711	3,354	980,188	5,387	89,694	11,732	106,813
81110GA	1	57	90	63,325	51	1,611	493	2,155
Total	—	2,768	3,444	1,043,513	5,438	91,305	12,225	108,968

according to paragraph *a* above, an electrical power generation plant should be provided.

(5) *Step 5.*

(a) Begin a search for the electrical generating plant. The required capacity must be at least 1,203 kW, according to the installation description. Consult the index to the Listing of Facilities in order to locate the page where "Electrical Generation and Distribution Equipment" begins. Search for a plant that provides 1,203 kW. Since the next plant larger than 1,230 kW is a 1,500-kW facility, you must decide whether it would be best to over design slightly or over design considerably.

(b) With that decision in mind, review the available generating plants, 81110GA through 81110GK. Using information from the facility description and drawing, you can narrow the possible choices to 81110GA, 81110GB, and 81110GC. All are temporary standard of construction facilities and each includes a building.

(c) The facility description and the schedule of facilities and drawings on sheet 81110GA-GK, sheet 1, (in TM 5-302) show, however, that for the 1,500-kW generating plant, four 500-kW generators are actually installed, and for the 2,000-kW generating plant, five 500-kW generators are installed. Because of the reserve capacity of 81110GA and the fact that the peak demand of 1,203 kW would be 1.5 percent greater, the best choice would be the 1,500-kW generating plant, 81110GA.

(6) *Step 6.* After all of the required installations or facilities are picked, check if any existing facilities can fulfill part of the requirement. If so, the new facilities that are redundant can be eliminated from the list of components to be acquired.

(7) *Step 7.* Complete the list of installations and facilities, and tabulate the logistics and cost data and construction effort as shown in table 4-1. Consult TM 5-303 (BOM) for a detailed list of materials and construction effort estimates. The items in paragraphs (a) and (b) below should be considered when using TM 5-303:

(a) TM 5-303 provides a detailed list of materials for each facility in order to ensure that specific items are not omitted. However, do not assume that the BOM is absolutely correct. Although the BOM measures materials by units and tenths of a unit of issue for each facility, smaller increments may actually be required.

(b) When using the construction effort estimates to figure the total duration, consider any unusual or extenuating circumstances (such as troops adjusting to a very hot climate).

(8) *Step 8.* TM 5-302 contains all relevant construction drawings. The drawing numbers for installation GH0361 are listed in the installation index in TM 5-302. (The drawing uses the same number as the installation.) Note that drawings for the individual facilities, such as the generator plant, are determined by the facility number. For example, drawings for the generator facility 81110GA are found on 81110GA-GK in TM 5-302.

*b. Example Problem 6.* Construct, for a temperate climate, a port facility to handle 1,000 tons of break-bulk cargo per day. Assume a tidal range of approximately 15 feet and use the temporary construction standard and wood frame buildings. Assume that an additional 8,000 square feet of warehouse space will be required. Utilities (electricity and water) need not be provided, since they will be supplied from a nearby installation. The solution procedure is described in paragraphs (1) through (6) below.

(1) *Step 1.* Identify the climatic zone. Since the facility will be in the temperate zone, use TM 5-301-1.

(2) *Step 2.* Determine whether to look for the data under the Listing of Installations or under the Listing of Facilities. Since a port will consist of many facilities, such as a pier, wharf, building, and warehouses, it would be listed as an installation.

(3) *Step 3.* Check the index of the Listing of Installations for temperate climate in TM 5-301-1. Locate the page where "Port, Break-Bulk Cargo" begins. Review



Table 4-2. Tabulations for example problem 7

	Quantity	Materials			Construction Effort in Man-Hours			
		Weight short tons	Volume measured tons	Cost \$	Horizontal	Vertical	General	Total
FP1105	1	122,485	138,731	97,029,518	136,833	165,338	99,618	401,789
44110EA	2	10	11	1,943	23	262	53	338
Total	-	122,495	138,742	97,031,461	136,856	165,600	99,671	402,127

each port installation until the required size, standard of construction, and type of construction are found. The best choice appears to be FP1105.

(4) Step 4. Check whether the final product will require additional facilities or installations. For example, this problem requires an additional 8,000 square feet of warehouse space.

(5) Step 5. To fill the extra warehouse space requirements, search through the Listing of Facilities as described in step 3 of example problem 5 above, or check for the facilities listed under the selected installation. Facilities that exactly match the requirements can be ordered. For instance, facility 44110EA (which is one of the components of installation FP1105) is a closed, wooden warehouse with a capacity of 4,000 square feet. The additional space required is 8,000 square feet; therefore, ordering two additional warehouses of type 44110EA would meet the requirement.

(6) Step 6. The remaining procedures are the same as in steps 6, 7, and 8 of example problem 5 above. Tabulate the cost, logistics, and construction data as shown in table 4-2. The drawing number listed in the installation description is FP1015-1065. The drawing number for the wood frame warehouse building is 44110BC-44110EK. Both of these drawings are in TM 5-302.

c. Example problem 7. Construct, for the temperate zone, a basic 20-foot-wide by 70-foot-long by 8-foot-high wood frame building with concrete foundation. Insulation will be required for the walls and ceiling. The building is to be temporary standard of construction. (Note that all wood and steel frame buildings in AFCS are designed for temporary standard of construction.) Utilities for the building will be installed later and are not be a part of this problem. The solution procedure is described in paragraphs (1) through (4) below.

(1) Step 1. Use TM 5-301-1, since the building will be located in the temperate zone.

(2) Step 2. Check the index of the Listing of Facilities under "Buildings, Wood," since an individual building that does not provide any specific service should fall under the facility category.

(3) Step 3.

(a) A review of the facility section under wood frame buildings shows that no building listed exactly fits the stated requirement; therefore, several subfacilities of components must be assembled. Examine the facility listing carefully, looking for compatible components.

(b) Facility 93121AK provides a complete 20-by-60-foot basic building with a concrete floor and all required windows and doors indicated in the design (see figure 4-2). The design permits the construction of any length building in the 20-foot-wide series; however, only selected standard AFCS lengths are presented with descriptions and material lists. In order to construct a nonstandard 70-foot-length building, the planner would use the 60-foot building and add the following components:

- 1 each 93121HB, 10-foot interior bay
- 1 each 93191GA, concrete-footing stem wall, 20 feet
- 0.2 each 93191GF, concrete slab floor, 4-inch-thick, 1,000 square feet
- 1 each 93195AC, window, 4 by 4 feet (if required)
- 1 each 93195AB, personnel door (if required)

(c) Remember, the design allows the construction of any length without a design change. The following additional building enhancements could be selected by the planner, depending on the intended construction site and building use:

- 93192AA-JH, electrical designs
- 93194AA-JF, interior components
- 93195AA-AC, exterior components
- 93196AA-AE, insulation

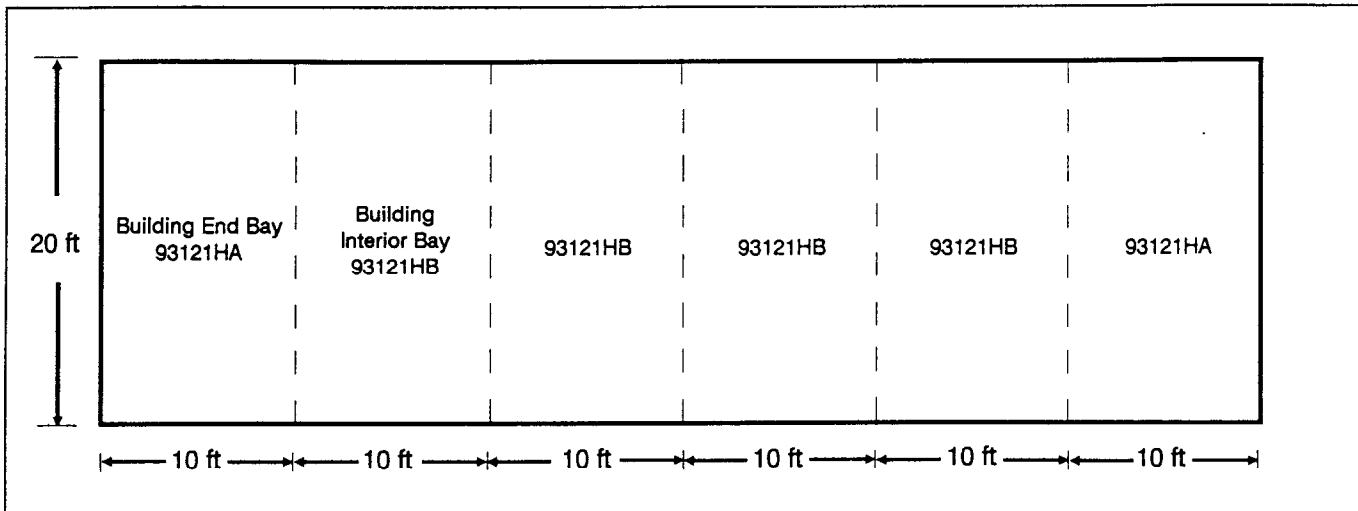

Figure 4-2. Components of a 20-by-60-foot building

- 93197AA-AD, ventilation
- 93198AA-AY, air-conditioning

(4) As a rule, all subfacilities are compatible with all building systems; however, some building components for pre-engineered metal, fabric frame, or lightweight panelized buildings must be procured as part of the structure itself. Those components include insulation, some ventilation components, window, doors, and tropical eaves. When combining components or subfacilities for a final product such as a building, use subfacilities from the same or a compatible system.

#### 4-4. USING AFCS IN PLANNING AND DESIGN

a. *General Procedures.* Figure 4-3 show a flowchart of the general procedure for using AFCS in planning and design. Information and directives from higher planning headquarters and information from local sources that must be considered during various steps of the procedure are shown in large circles. The decision point and check point are shown in squares, the outputs of specific steps in rectangles, and inputs from AFCS manuals (TM 5-301, TM 5-302, and TM 5-303) in small circles. Each item is tagged with its corresponding paragraph number.

b. *Sources for Information and Directives.* Information and directives from higher-planning headquarters and information from local sources are described in paragraphs (1) through (5) below:

(1) *Base Development Plan (BDP) and Construction Directives.* The major directive may include selected

base sites, assigned support mission, operational target dates, scope of construction requirements, etc. The plan may also specify priorities and construction standards and allocate resources and real estate.

(2) *Terrain Information and Requirements.* Terrain information includes map reconnaissance, site reconnaissance, climate, and soil. Terrain requirements are provided in the BDP, which specifies concealment requirements and the level of mobility expected.

(3) *Available Existing Facilities.* Information about existing facilities could come from higher-planning headquarters or local intelligence sources. Existing facilities may include buildings, utilities, roads, etc.

(4) *Local Resources.* Information about local resources could come from intelligence sources. Local resources include availability of skilled craftsmen, general construction labor, and construction materials such as steel, lumber, cement, and aggregate.

(5) *Construction Resources.* Construction resources include both the engineer unit or units assigned by the higher-planning headquarters and any available civilian laborers who will perform the construction tasks.

c. *Decision and Verification Points.* Decision and verification points are described in paragraphs (1) and (2) below:

(1) *Materials and Construction Technology.* The choice of materials depends largely on the facility type and is constrained by the standard of construction. Several types of construction technology are available through AFCS, including wood frame, steel frame, and

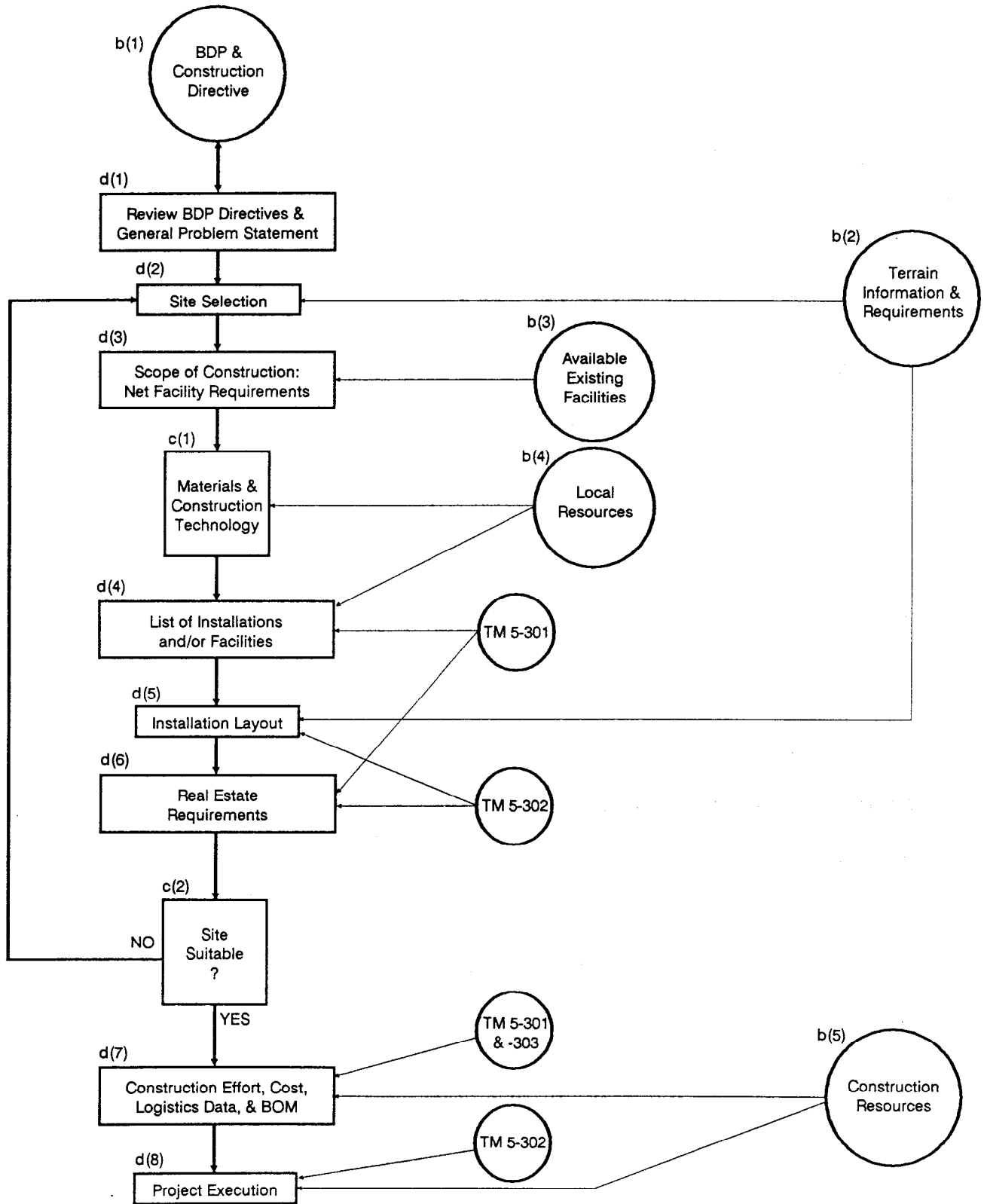

Figure 4-3. AFCS planning and design procedure flow

prefabricated buildings. The selection of a particular building type should be based on the availability of materials, time constraints, and the types of skilled craftsmen needed.

(2) *Site Suitability.* The estimates of total real estate requirements are based on the final installation layouts. The results are compared with those of the previously selected or assigned sites, and then steps are taken to acquire any needed additional land.

d. *Planning, Design, and Estimating.* The planning, design, and estimating stages that generate requirements are explained in paragraphs (1) through (8) below:

(1) *General Problem Statement.* The BDP should be reviewed for thoroughness and consistency; then, a general problem statement should be formed. The statement should consist of military plans and support requirements in terms of the tasks to be done by the construction unit and the resources available to do them. The statement should also include information about size, location, climate, standard of construction, etc.

(2) *Site Selection.* The land estimate is based on the construction requirements. Information about candidate sites is evaluated, using the estimate and the terrain requirements. The most promising sites are inspected by a reconnaissance team, and then a site is chosen.

(3) *Scope of Construction.* The net facility requirements can be determined by examining the overall facility requirements and any usable existing facilities such as buildings, utilities, etc.

(4) *List of Installations and/or Facilities.* On the basis of the scope of construction requirements and the construction standard, a list of installations and facilities (identified by their numbers) can be developed. TM 5-301 is used to select the desired installations and facilities. (See previous example problems for details.)

(5) *Installation Layout.* TM 5-302 gives the recommended layout of facilities within the installation; however, the recommended layout may need to be revised to meet terrain requirements and other site-specific conditions such as existing buildings, roadways, utilities, and dispersal.

(6) *Real Estate Requirements.* TM 5-301 gives the quantity of land required for the recommended facility layout. If the recommended layouts are not used, the actual required land area should be calculated based on

the revised layout. AFCS installation designs are generally based on minimum real estate requirements.

(7) *Construction Effort, Cost, Logistics Data, and BOM.* TM 5-301 and TM 5-303 provide the estimated construction man-hours, cost, and logistical data for transportation; TM 5-303 also provides the BOM. The number of man-hours required for all horizontal, vertical, and general construction should be tabulated and compared with the number of man-hours available from construction units in each category. If there are deficiencies, additional man power support should be requested. The total time needed to complete all construction can be estimated on the basis of the available man power and the number of man-hours required for construction.

(8) *Project Execution.* Project execution ends the planning steps discussed in paragraphs (1) through (7) above. The working drawings in TM 5-302 provide information of various construction resources (including engineer units and civilian labor) used to execute the project.

e. *Example Problem 8.*

(1) *Problem Statement.*

(a) *General.* A cantonment is required for five companies, or about 1,000 troops. A 55-acre site has been selected and is suitable for construction without major grading and clearance operations. The camp will be located in a temperate zone and will be turned over to allied forces at the end of hostilities; therefore, the temporary standard of construction would be the most suitable.

(b) *Water Treatment and Distribution.* Potable water is not available from local communities; however, intelligence sources indicate that good well water should be available within 250 feet of the surface. Water storage should be provided for about 40 to 50 percent of the daily demand as called for in the installation description.

(c) *Sewage Collection and Treatment.* All waste water from the camp must receive primary and secondary treatment before being discharged into any local streams. Local code requirements do not allow pit latrines within the cantonment; therefore, a waterborne sewage treatment facility will be required.

(d) *Electrical Power and Distribution.* Intelligence shows that the local power generation capacity is insufficient and unreliable. Assume that power genera-

tion with a 30-percent emergency backup capacity will be required.

(e) *Recreation and Service Requirements.* Assume that a chapel with a capacity of at least 25 percent of the camp's population will be required. No athletic courts or theater are scheduled at this time.

(f) *Roads.* There is bituminous surfacing on many roads in the vicinity, so no major road-building projects are anticipated. An abundance of good aggregate can be found nearby.

(g) *Resources.* About 300 civilians will be available for general labor tasks. One line company from a combat engineer battalion (heavy) will be available to work on the project.

(2) *Problem Solution.* Figure 4-3 shows the procedure for solving this type of problem. The planning, design, and estimation stages explained in paragraphs (3) through (9) below correlate with parts d(1) through d(7) of figure 4-3.

(3) *BDP-d(1).* Review the BDP directives and the general problem statement and summarize the basic requirements.

(4) *Site Selection-d(2).* Since a site has been assigned previously, no action is needed now. Later, it will be necessary to verify that the site is large enough and is suitable for constructing the project.

(5) *Scope of Construction-d(3).* All construction will be new, since no facilities in the area, except the roads, can fulfill any requirements of the problem statement.

(6) *List of Installations and/or Facilities-d(4).*

(a) *General.* The best way to approach the problem is to select from TM 5-301-1 the smallest component that will satisfy the mission requirement. For this problem, the temporary standard has been specified. Begin by scanning the index of the Listing of Installations in TM 5-301-1 and turn to the first page of "Camps, Troop." Note the verbal description of each installation in the upper left-hand corner of the page. Check the listing page-by-page and find a 1,000-man, temporary standard, wood frame troop camp that can be used (such as installation NT1531). To determine the most suitable type of construction (steel or wood frame), consider the following: availability, engineering effort required, timeframe for completion, logistical requirements, and cost.

(b) *Choice of Materials.* Normally, the most important consideration is the availability of materials. Since wood is usually readily available, NT1531 (wood frame) is probably the best choice, assuming the other constraints listed in (a) above are of little consequence. Based on DOD planning factors, the installation requires 25,000 gallons of water per day, generates 17,500 gallons of sewage, requires 52.1 acres of land, and requires at least 485.5 kW of electrical generation capacity.

(c) *Chapel.* Since the chapel building serves a specific purpose, it is listed in the facilities section. In the index of the Listing of Facilities, find the page number for chapel listings; from that page search page-by-page until a suitable facility is found. Facility number 74018AU, a wood frame chapel with 300 seats, appears to be the best choice, since it is the smallest available facility meeting the basic requirement of seating 25 percent of the camp's population.

(d) *Water Treatment Plant.* In the index of the Listing of Facilities, find the page number for "Water Supply and Treatment" and search page-by-page for a facility that meets the problem's requirements. Facility 84120AB will supply up to 60,000 gallons of water per day. That facility consists of a deep-well hypochlorination unit with 21,000 gallons of elevated storage, yielding a storage capacity of 84 percent (21,000 gallons storage/25,000 gallons daily demand x 100) of the total daily demand, and thus provides more than the percentage of storage required. However, one of the two 10,500-gallon elevated storage tanks could be deleted from the facility, reducing storage to the required 40 to 50 percent.

(e) *Sewage Treatment Plant.* Select a sewage treatment plant in the same way a water treatment plant was selected in (d) above. Consider plant capacity first. TM 5-301 shows that facility 83110AA can handle 25,000 gallons per day. Since facility 83110AA is the first installation listed exceeding the required 17,500 gallons per day and offering both primary and secondary treatment as required in the construction directive, it appears to be the best choice.

(f) *Electric Generating Plant.* The electric generating plants are found in the Listing of Facilities of TM 5-301. To determine the capacity of the generators, tabulate the loads of the various components to be ordered and add an additional 30 percent as called for in the construction directive:

Table 4-3. Data for various construction components

Facility or Installation	Materials			Construction Effort in Man-Hours			
	Weight short tons	Volume measured tons	Cost \$	Horizontal	Vertical	General	Total
Camp NT1531	3,473	3,234	516,870	5,492	32,172	8,820	46,484
Chapel 74018AU	48	57	8,879	32	1,340	78	1,450
Water Supply 84120AB	21	47	24,204	484	129	220	833
Latrine (Drop) 72312BC	-5	-6	-1,028	0	-112	-16	-128
Sewage Plant 83110AA	140	302	83,420	69	4,533	300	4,902
Generator 81110GA	112	267	198,408	105	3,798	949	4,852
Total	3,789	3,901	830,753	6,182	41,860	10,351	58,393

- Basic camp 485 kW
- Chapel (insignificant)
- Water treatment (insignificant)
- Sewage treatment 25 kW
- Total 510 kW
- Total with 30% backup added 663 kW (minimum)

Find a generator plant of suitable capacity by scanning the various generator and enclosure combinations in TM 5-301 and by consulting drawing 81110GA in TM 5-302 for the schedule of facilities. Facility 81110GA, which has a nominal rating of 1,500 kW, is a suitable choice, since it is the smallest nontactical generator.

(7) *Installation Layout--d(5)*. Consult TM 5-302 for applicable construction drawings of troop camp NT1531. A complete site analysis should be done to ensure a workable final product. Obviously, the water treatment plant must be close to the water supply, and the sewage treatment plant should be situated both downstream and downwind of the camp. The generator building should be located on higher ground in order to avoid the risk of flooding. Other factors, such as site access, security, and solar orientation, should also be considered.

(8) *Real Estate Requirements--d(6)*. The total land area required for the camp can best be determined by adding the various component requirements:

- Basic camp 52.1 acres

- Water treatment 1 acre
- Sewage treatment 1 acre
- Generator and chapel (negligible)
- Total 54.1 acres

Assuming that all parts of the assigned 55-acre site are usable, the land area should be sufficient for the troop cantonment and support facilities. Therefore, the site would be considered suitable, and there would be no need to return to the site selection process.

(9) *Construction Effort, Cost, Logistical Data, and BOM--d(7)*.

(a) By setting up a table of data for the various components, the planner can easily determine the total cost, shipping requirements, and construction effort required for the project (see table 4-3).

(b) Assume that one line company from a combat engineer battalion (heavy) is available to work on the project. TOE 5-118H indicates that the estimated effort available from a combat engineer company (heavy) is 2,877 man-hours of vertical effort, 3,288 man-hours of horizontal effort, and 17,466 man-hours of general effort per company month (CO MO). For this problem, it is assumed that the 17,466 man-hours of general effort will be applied to the vertical effort; therefore, those values are added civilian man-hours available per month and can be calculated as shown in the following equation:

$$(\text{Civilian Laborers Available}) \times (\text{Hours/Day}) \times (\text{Days/Month}) = \text{Civilian MH/MO}$$

$$\begin{aligned} \text{Horizontal Duration} &= \frac{\text{MH Required}}{\text{MH Available/CO MO}} = \frac{5,615 \text{ MH}}{3,288 \text{ MH/CO MO}} = 1.71 \text{ CO MO} \\ \text{Vertical Duration} &= \frac{\text{MH Required}}{\text{MH Available/CO MO}} = \frac{70,740 \text{ MH}}{20,343 \text{ MH/CO MO}} = 3.48 \text{ CO MO} \\ \text{General Labor Duration} &= \frac{\text{MH Required}}{\text{MH Available/MO} \times \text{EFF}} = \frac{20,487 \text{ MH}}{(300) \times (12) \times (30) \times (.60)} = 0.32 \text{ MO} \end{aligned}$$

*Figure 4-4. Calculations for project duration*

(c) Since local labor is likely to be less efficient than troop labor, multiply the civilian man-hours/month by the civilian efficiency in order to compensate. For example, assume 60-percent efficiency:

$$(\text{Civilian MH/MO}) \times (.60) = \text{Actual Civilian MH/MO}$$

(d) Assuming the work is done by a combat engineer company (heavy) and 300 civilians, the calcula-

tions for project duration would be as indicated in figure 4-4. Those durations do not consider construction sequencing. Chapter 3, which discusses CPM networks, gives a detailed and accurate approach. However, as a rough estimate, the project duration would be determined by the largest of the three values, or about 3.48 company months.

## CHAPTER 5

### REQUISITION AND SUPPLY

#### 5-1. CONSTRUCTION SUPPLIES

*a. General.* Paragraphs b through d below describe the functions of the various DOD agencies that supply construction items.

*b. Army Materiel Command (AMC).* AMC develops the material management procedures, policies, and guidance needed to acquire, store, and ship materials needed for construction of AFCS facilities. AMC responsibilities are outlined in AR 415-16.

*c. Deputy Chief of Staff for Supply, Maintenance, and Transportation.* The Deputy Chief of Staff for Supply, Maintenance, and Transportation, Headquarters, U.S. Army Materiel Command (AMCSM) in Alexandria, Virginia, coordinates AMC activities and interests pertaining to AFCS (such as materiel development, procurement policies, employment support, and related matters), and ensures that AMC can support the demands for construction materials during emergency and contingency operations.

*d. U.S. Army Troop Support Command (TROSCOM).* TROSCOM (a subcommand of AMC located in St. Louis, Missouri) is the central point within CONUS for coordination with the Federal Supply System and for acquiring construction materials for AFCS construction. The responsibilities of TROSCOM are to:

(1) Provide AFCS data to Worldwide Inventory Control Points, Army Class Manager Activities, the Defense Logistics Agency (DLA), and the General Services Administration (GSA) supply sources.

(2) Develop, upon receipt of message requests, the BOM by NSN for requested AFCS facilities and installations, and request project codes from Logistics Systems Support Activity (LSSA), Chambersburg, Pennsylvania.

(3) Prepare logistics capability estimate requests and forward them to appropriate DLA's, GSA's, and other National Inventory Control Points (NICP's) in order to obtain an item's availability status.

(4) Prepare requisitions by NSN in order to provide (in accordance with AR 725-50) 100-percent supply shipment status for all items required.

(5) Furnish (in accordance with AR 710-1) item managers with a copy of the BOM, including submission of any special program requirement data and the appropriate requisitions.

(6) Maintain detailed followup and status of requisitions in order to ensure timely shipment and provide a quarterly recapitulation.

(7) Furnish AMC with a yearly summary of major actions pertaining to AFCS facilities or installations.

(8) Catalog and standardize AFCS-required materials; coordinate that action and the acceptability of substitute items with Huntsville Division; revise the SIMF as required.

(9) Ensure that consumer funds are available before supplying NSN items.

(10) Coordinate requirements with the appropriate Logistics Control Office and the Military Traffic Management Command in order to furnish lift information for each project code.

#### 5-2. REQUISITIONING PROCEDURES

*a. Requesting By AFCS Number.* Supply procedures in a TO are generally established by the theater commander and may vary according to local circumstances. AFCS facilities and installations may be requested by sending AFCS numbers (such as 21410GE) by message through channels to TROSCOM. Users can request AFCS facilities or installations with or without certain facilities, subfacilities, and individual items, as required. At a minimum, the message should include the following items:

(1) Facility or installation number, additions and/or major deletions, and the quantity required.

(2) Funding authority.

(3) Priority.

(4) Destination and shipment information (port, construction site, depot, and "Mark for-Ship to").

(5) Date required.

(6) Method of shipment (from an assembly depot as a complete package or separate line items from supply sources).



*b. Requesting By NSN.* The forms and procedures used for the Military Standard Requisitioning and Issue Procedure (MILSTRIP) method can only be used to requisition by NSN, not by AFCS facility or installation number.

### 5-3. METHODS OF SHIPMENT

Required construction materials are packaged for overseas shipment by one of the methods described in paragraphs *a* and *b* below:

*a. Shipped From An Assembly Depot As A Complete Package (All Items Shipped At The Same Time).* This method requires that TROSCOM establish an assembly depot that will prepare and identify all items listed in the BOM. Shipment is delayed until everything specified by the requester is ready for shipment. This method requires more lead time than the average MILSTRIP requisition; therefore, a construction project's start is restricted to the arrival of the item with the longest lead time.

*b. Shipped From Separate Supply Sources As Separate Line Items.* With this method, all items are shipped at different times; therefore, they must be labeled with the

appropriate project code for proper identification at the theater's destination. Project fill status is monitored in TROSCOM and determined in the theater.

### 5-4. FOREIGN PROCUREMENT

The supply procedures and construction materials identified in TM 5-302 apply when AFCS construction materials are requisitioned from CONUS; however, the supply procedures may not be valid for foreign sources procurement. Therefore, engineering design should be checked before procuring supplies in order to determine whether foreign construction materials are compatible with U.S. components. For example, materials and equipment based on the metric system should be checked for compatibility.

### 5-5. MATERIALS MANAGEMENT

When materials are received in the theater (by either shipping method outlined in 5-3 ), they will be managed in accordance with theater retail supply procedures.

### 5-6. FUNCTIONAL FLOWCHART

Figure 5-1 illustrates the requisition and supply process.

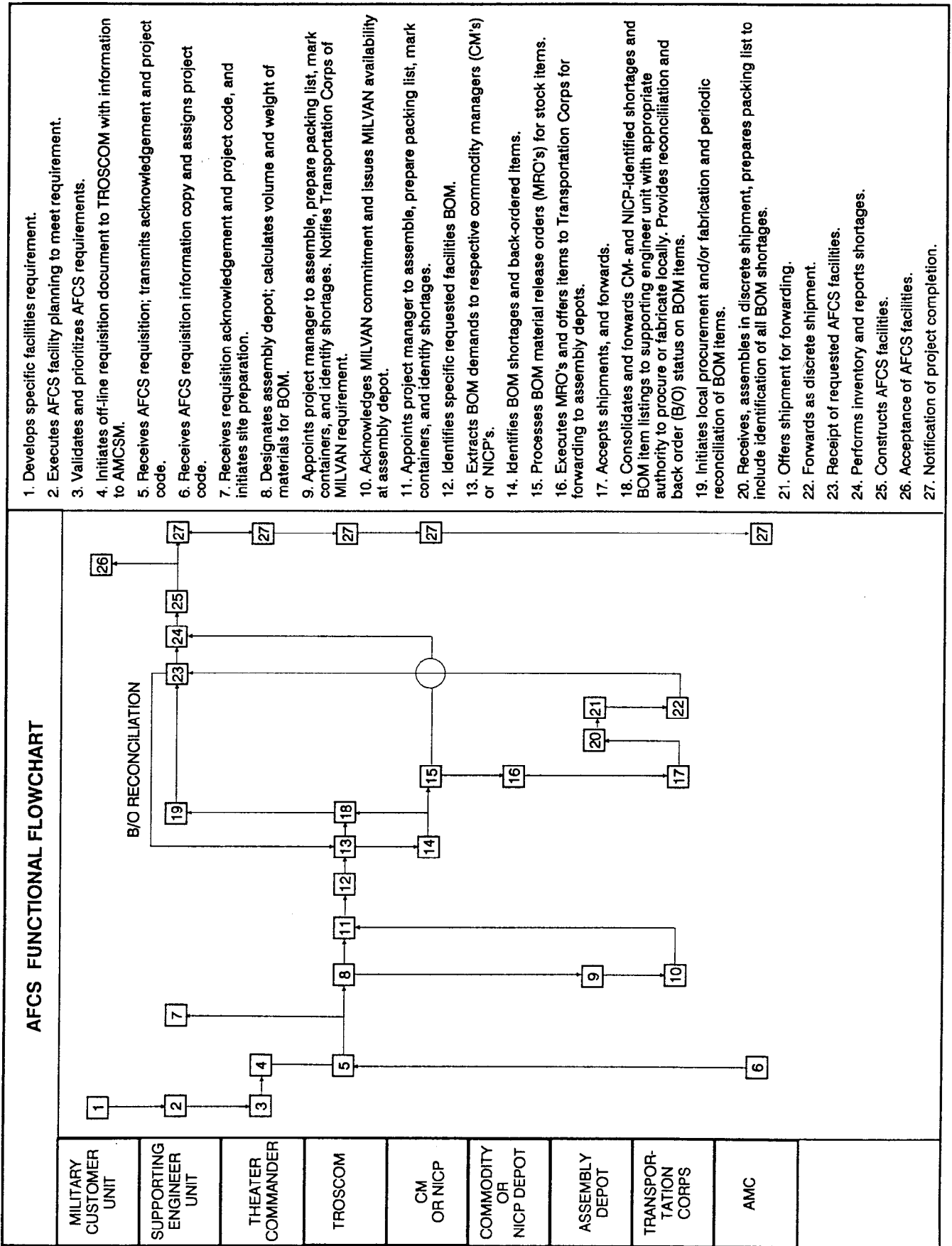

Figure 5-1. Requisition and supply process

## APPENDIX A

### REFERENCES

---

#### A-1. Army Regulations

- AR 415-16, Army Facilities Components System
- AR 415-28, Department of the Army Facility Classes and Construction Categories
- AR 570-2, Manpower Requirements Criteria
- AR 710-1, Centralized Inventory Management of the Army Supply System
- AR 725-50, Requisitioning, Receipt, and Issue System

#### A-2. Army Supply Catalog

- C1, Federal Supply Catalog

#### A-3. Field Manuals

- FM 5-20, Camouflage
- FM 101-10-2, Staff Officer's Field Manual: Organizational, Technical, and Logistical Data Extracts of Nondivisional Tables of Organization and Equipment

#### A-4. Technical Manuals

- TM 5-200, Camouflage Materials
- TM 5-301-1, Army Facilities Components System--Planning (Temperate)
- TM 5-301-2, Army Facilities Components System--Planning (Tropical)
- TM 5-301-3, Army Facilities Components System--Planning (Frigid)
- TM 5-301-4, Army Facilities Components System--Planning (Desert)
- TM 5-302-1, Army Facilities Components System: Design
- TM 5-302-2, Army Facilities Components System: Design
- TM 5-302-3, Army Facilities Components System: Design
- TM 5-302-4, Army Facilities Components System: Design
- TM 5-302-5, Army Facilities Components System: Design
- TM 5-303, Army Facilities Components System – Logistics Data and Bills of Materials

#### A-5. Huntsville Division Manual

- CEHND 1105-1-1, TACAPS User Guide

## APPENDIX B

### CAMOUFLAGE AND DISPERSAL

#### B-1. DEFENSIVE MEASURES

*a. Types.* An installation's ability to survive are enhanced by two basically complementary defensive measures: active and passive. The best defense is built on a combination of those two measures, rather than depending on either category alone. However, each local situation must be assessed in order to determine the most effective mix of defense methods. For example, some locations might lack adequate land area for dispersal and will rely primarily on active defense measures, although in such cases, the threat may be so limited that active measures would not be required.

*b. Active Measures.* Active defenses complement passive defenses by degrading the accuracy of weapons delivery and by limiting the effectiveness of enemy ground and air attack. Active defense can save resources by destroying some or all of the attacking force before an attack or by degrading the electronics of enemy weapons systems, rendering them ineffective. Use of antiaircraft units and ground security forces can significantly improve an installation's survivability chances by limiting the strength and number of enemy attacks. The effectiveness of active defenses can be measured in terms of what is saved and the attrition rate of enemy forces.

*c. Passive Measures.* Passive defenses, such as camouflage and dispersal, complement active defenses by rendering the target difficult, if not impossible, to locate and contain. Passive measures can force the enemy to use weapons and tactics that increase exposure to active combat units, antiaircraft, and perimeter security forces. The effectiveness of passive defenses can be measured in terms of targets saved or in terms of increased enemy effort. This chapter discusses how camouflage and dispersal can increase base security.

#### B-2. CAMOUFLAGE

Camouflage is a concealment technique that includes hiding from view, making it difficult for the enemy to see clearly, arranging visual obstructions, and disguising objects. When used correctly, camouflage can minimize a fixed installation's vulnerability to enemy attack. Furthermore, camouflage can be thought of as a counter-surveillance technique because it can mislead, confuse, or deny vital military information to enemy surveillance systems. Although a fixed installation usually cannot be totally

concealed, camouflage should at least conceal key elements, forcing enemy intelligence to draw incorrect conclusions about an installation's operations.

##### *a. Concealment Principles.*

*(1) Surveillance Technology.* With advancements in the technology of surveillance systems, creating sophisticated sensors and weaponry that effectively camouflage a fixed installation has become increasingly difficult; however, certain concealment principles remain effective for enhancing the probability of an installation's survival. Paragraphs (2) and (3) below briefly discuss the principles of concealment from both direct (people) and indirect (photographic) observation.

*(2) Recognition Factors.* Since the eye is the most adaptive and responsive sensor, the objective of fixed installation camouflage is to confuse and deceive the eye by countering the factors that the eye needs to identify objects. Paragraphs (a) through (f) below explain those recognition factors.

*(a) Shape.* All objects have a characteristic shape or outline that identifies them even before details can be seen. Camouflage can hide or disguise the shapes of standard recognizable objects.

*(b) Shadow.* An object's characteristic shadow, or projection of its shape, may be more revealing than the object itself, especially if viewed from above. A shadow can be disguised by ground patterns, plantings, or false forms.

*(c) Color.* Color can aid an observer if there is a contrast between the object and its background. Light or bright colors tend to attract the eye, whereas darker or subdued colors tend to blend an object into the background.

*(d) Texture.* Texture refers to an object's ability to reflect, absorb, or diffuse light and can be defined as the relative roughness or smoothness of an object. For example, an airstrip, even though painted to match adjacent grassy areas, will appear much lighter in an aerial photograph because the textures differ.

*(e) Position.* An object can often be identified by its position in relation to its surroundings. For example, a long object on a railroad track is assumed to be

a train. Similar objects on a river floating parallel to its banks are assumed to be boats or barges.

(f) *Movement*. Movement does not necessarily identify an object, but will draw an observer's attention. Vehicle tracks or a change in the position of a piece of equipment can be as noticeable as movement to trained observers.

(3) *Concealment*. Two principles of concealment--siting and discipline--can diminish the negative effects of the recognition factors listed in (2) above.

(a) *Siting*. The purpose of siting is to select the most advantageous location for hiding an object. Often, a site's natural slope and vegetation make elaborate camouflage unnecessary. Vital elements can be dispersed in order to blur the installation's tactical mission and increase its likelihood of survival during an attack.

(b) *Discipline*. For fixed-installation camouflage, all personnel must adhere to the concealment principles used to protect the installation. For example, if a crane on a loading dock is carefully concealed, but empty oil drums, litter, and vehicle tracks can be seen around the area, then security has been compromised. Observers could then deduce that the concealed object is critical without ever knowing exactly what it is.

#### b. *Concealment Methods*.

(1) *Traditional Methods*. Individuals charged with camouflaging an installation have traditionally used four methods of concealing structures and activities:

(a) *Hiding*. Obstruct a sensor's field of view with natural terrain or foliage.

(b) *Deceiving*. Mislead the enemy by manipulation, distortion, or falsification of evidence, inducing the enemy personnel to react in a manner prejudicial to their interest.

(c) *Blending*. Match an object's reflectance characteristics to its background.

(d) *Disguising*. Give a sensor a false impression about an object.

(2) *Expanded Methods*. However, in order to carry out a successful camouflage operation, the four traditional methods must be expanded. Therefore, five more camouflage methods should also be considered:

(a) *Masking*. Obstruct a sensor's field of view with artificial cover such as a net.

(b) *Blinding*. Saturate a sensor, reducing its effectiveness or damaging it permanently.

(c) *Disrupting*. Eliminate or modify distinct object patterns.

(d) *Distracting*. Focus an enemy's attention away from an object.

(e) *Decoying*. Provide an effective false object.

c. *Runways and Taxiways*. Although runways and taxiways cannot be protected from detection if they are subject to continued visual and photographic aerial observation, they would be harder to recognize quickly at the usual bombing altitudes and speeds of modern aircraft if background color contrast were diminished and/or texturing materials added to tone down normal smooth and glaring surfaces.

d. *Modular Lightweight Camouflage Screening System*. AFCS does not include a camouflage facility for any structure. Instead, AFCS provides diagrams and charts that enable the user to develop adequate camouflage protection using the Army Modular Lightweight Camouflage Screening System. That system consists of a standard set of two nets (a hexagon and a diamond) and supporting equipment. Connecting the nets in various configurations produces the desired screen size. The Modular Lightweight Camouflage Screening System is not an AFCS design; therefore, it must be acquired separately, by NSN, through the supply system.

e. *More Camouflage Information*. Further discussion about camouflage is beyond the scope of this manual. It should be noted, however, that successful camouflage requires the use of locally available materials as well as the proper siting and dispersal of structures with regard to existing vegetation and terrain. For more information, see FM 5-20 and TM 5-200.

### B-3. DISPERSAL

Dispersal is a cost-effective passive defense measure that depends on tactical and operational requirements, terrain limitations, and available engineer resources. Dispersal eliminates the possibility of sympathetic explosions, complicates enemy attack, and causes the enemy to make multiple passes for each sortie in order to destroy the dispersed aircraft or facilities effectively. Some drawbacks of ground dispersal of aircraft are increased communications and security problems and possible new construction for additional taxiways and hardstands; on the other hand, dispersal should cause little or no degradation to a unit's operational capability. The relative merits of dis-

persal in any given situation must be weighed against the threat analysis and any extra man-hours required.

*a. Dispersal Principles.*

(1) *Separation Distances.* Optimum dispersion occurs when the enemy must attack each parked aircraft, vehicle, or facility as a separate target.

(2) *Site Choice.* Protection against enemy observation can be made much easier by choosing sites with a wide variety of ground features broken by irregular patches of trees and scrub growth.

(3) *Use Natural Terrain.* The dispersal (and camouflage) plan must take full advantage of terrain and its natural vegetation. The guiding principle should be to preserve the site's existing pattern and character.

(4) *AFCS Requirements and Dispersal.* The area and facilities of AFCS installations are based on operational requirements only; defensive measures beyond those for the anticipated minimal air threat in the communications zone are not emphasized. Therefore, the planner should consider increasing the number of linking facilities (roads, utilities, etc.) whenever significant dispersal is required.

*b. Dispersal Methods.*

(1) *Personnel Facilities.* Dispersal of personnel facilities depends on the limits of real estate, operational effectiveness, and installation security considerations.

(2) *Power Generation.* Installation power generation should be located in two separate areas, with several individual generators at each location. Those generators should be positioned with adequate separation between each unit in order to provide maximum survivability. Overhead power transmission lines and their transformers should be routed and spaced in a manner that will preclude the loss of more than one circuit as a result of one attack. Backup generator units that supply power to critical facilities, with their associated high voltage distribution centers and electrical distribution circuit cabling, should also be dispersed.

(3) *Maintenance Facilities.* Maintenance facilities should be dispersed so that separation is consistent with terrain features.

(4) *Stored Munition.* Accidental or deliberate detonation of stored munitions can be reduced by maximum separation between explosives and other resources. Explosives should be dispersed into small compatible groups. Ammunition storage should not be located on an area's periphery where it could be damaged easily by small arms fire.

(5) *Key Operations.* Splitting key storage or other operations into suboperations can provide effective dispersion. For instance, the storage of one type of conventional ammunition could be split between the operating sections of an ammunition installation in order to minimize the impact of an enemy attack. Key elements of an installation should be located so that they are properly concealed and protected from ground attack by infiltrators and guerrillas.

(6) *Petroleum, Oil, Lubricant (POL).* The survivability of POL storage and dispensing systems can be increased by use of air transportable systems. Those systems include portable storage tanks and dispensing systems that may be dispersed and surrounded by earthen dikes. Fuel should not be stored on the periphery of an area where it could be damaged easily by small arms fire.

(7) *Motor Vehicles.* Motor vehicles should not be pooled. Parking motor vehicles under or beside trees or next to earthen embankments can provide dispersal as well as partial concealment.

(8) *Aircraft.*

(a) *Parked Aircraft.* Random dispersal of parked aircraft can increase their survivability during an attack, since sortie requirements of attacking aircraft increase from two to four times when aircraft parked at 50-foot separations are changed to irregular parking with minimum separations of 300 feet. An aircraft dispersal plan should take into consideration operational requirements, maintenance, base security, existing parking areas, and the availability of real estate for additional aircraft parking.

(b) *Runways and Taxiways.* A survivability measure for runways and taxiways is base selection. A runway of minimum length and width could be made useless when hit with one bomb; however, portions of a larger runway could be used for emergency launch and recovery of aircraft after several hits.

(c) *Air Traffic Control Facilities.* Navigational aid and air traffic control facilities normally should be dispersed because operational considerations require that they be isolated from other facilities.

(d) *Dispersal Layouts.* Figures B-1 through B-4 show proposed layouts and dispersal patterns that may meet a variety of tactical operations with minimum construction effort. Those layouts were developed as guidance for field commanders and units in TO's and for use by planners at higher levels of command.

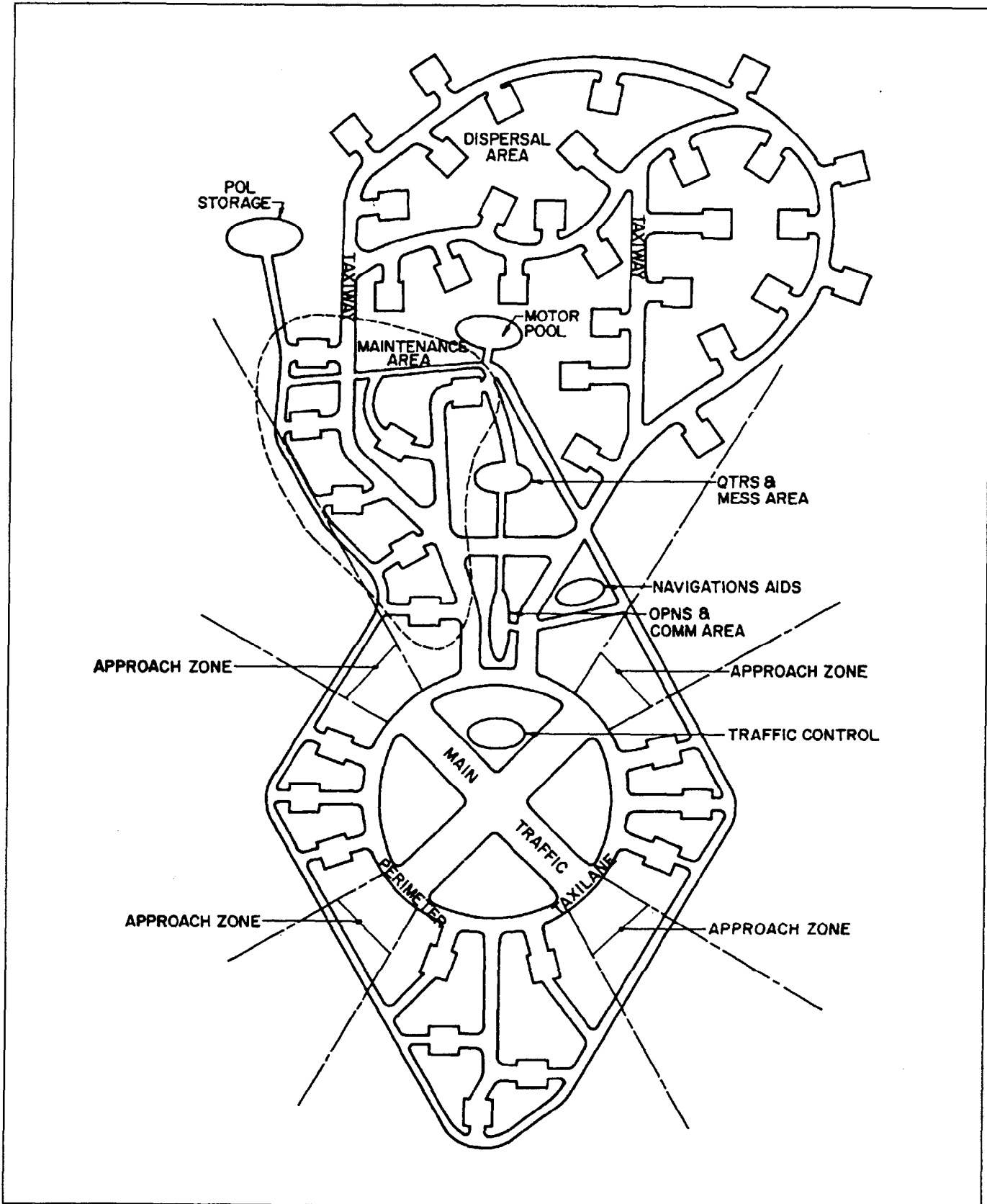

Figure B-1. Dispersal heliport layout

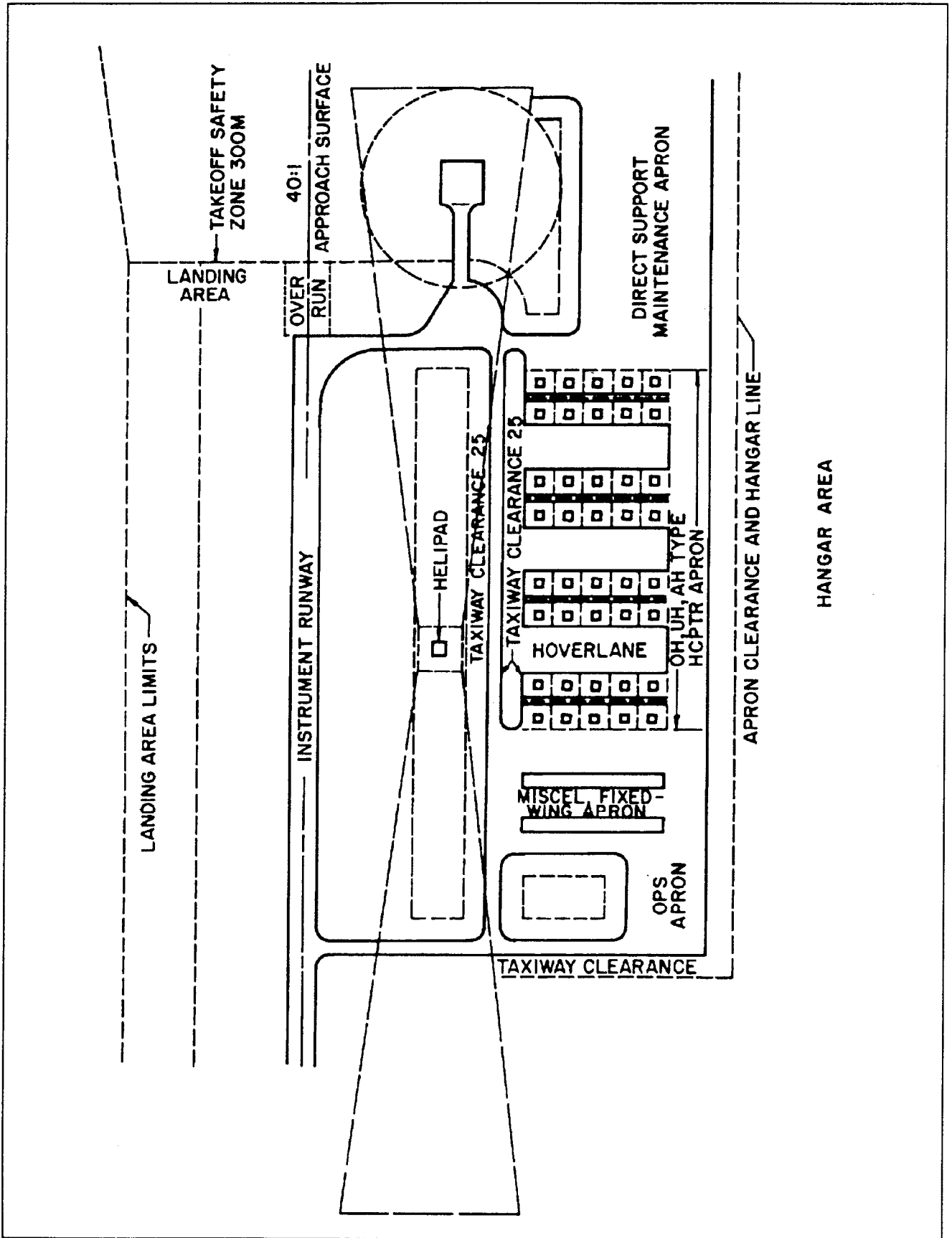

Figure B-2. Heliport layout, friendly air superiority



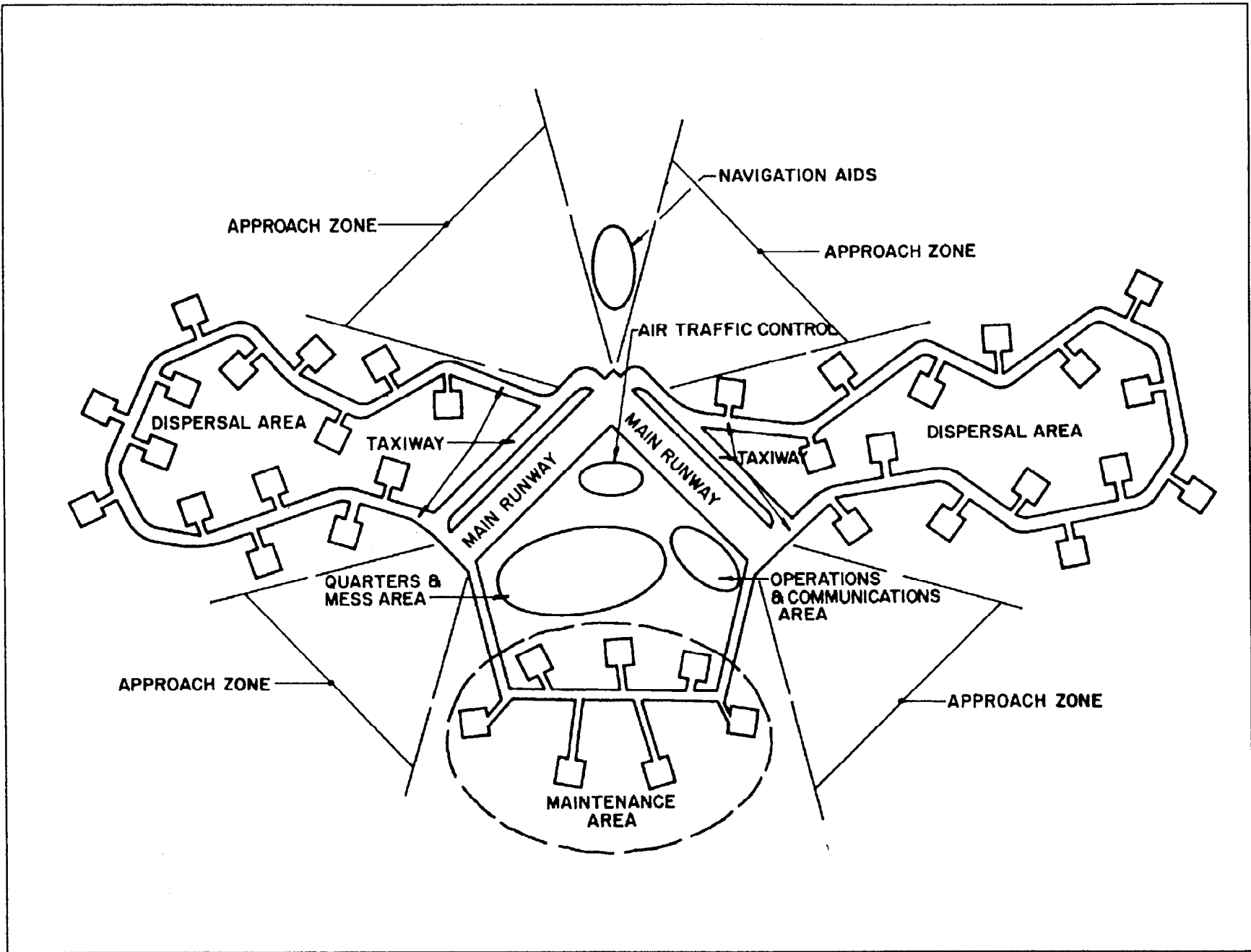

Figure B-3. Layout, all types of aircraft

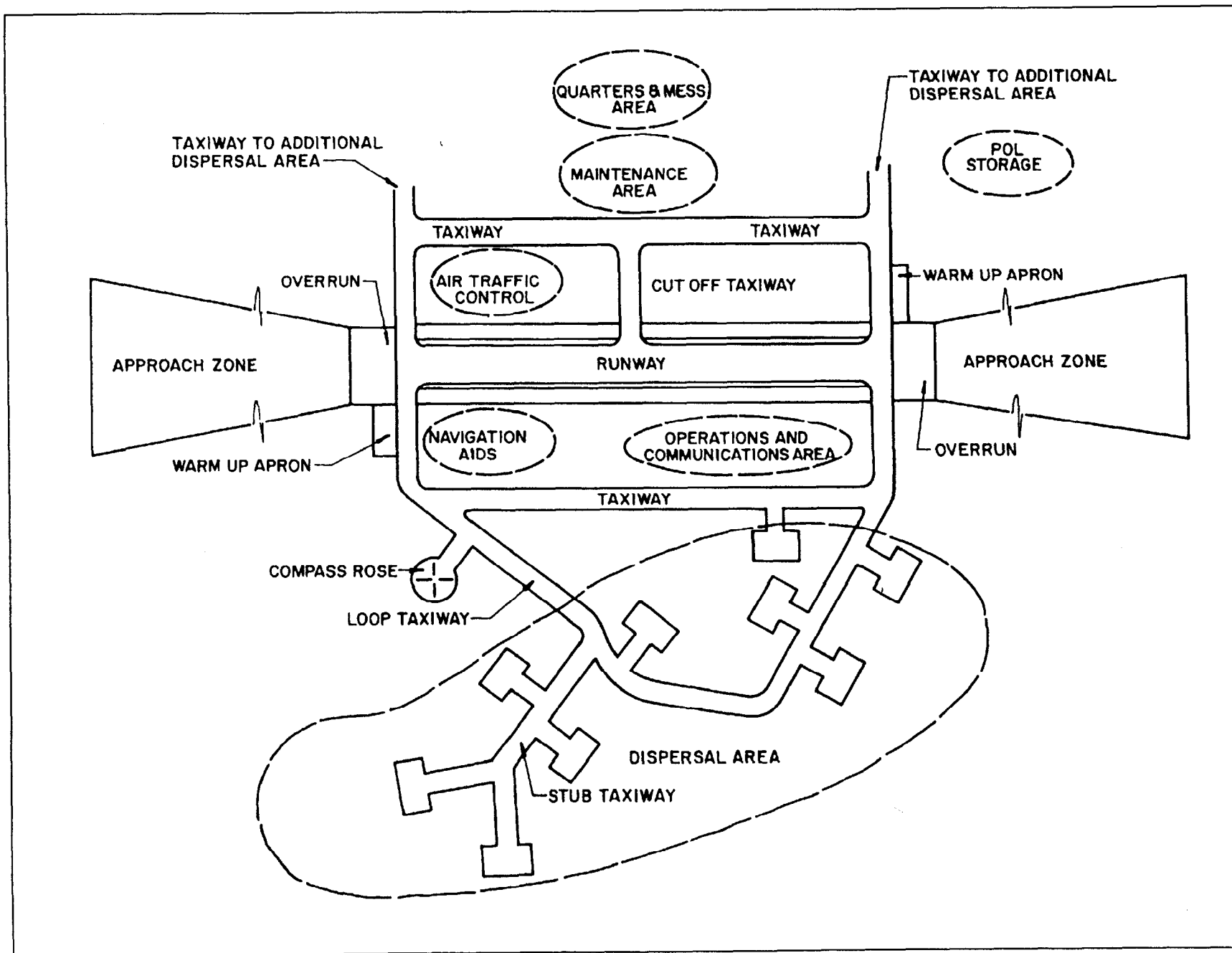

Figure B-4. Fixed-wing aircraft layout

## APPENDIX C

### BOMB DAMAGE REPAIR MATRIX

DAMAGED FACILITY	DESCRIPTION OF DAMAGE	FACILITY NO.	TITLE	REMARKS
Airfield pavements: runway, taxiway, or apron	Three 50-foot-diameter craters were caused by 750-lb bombs.	11150AF	Rapid runway repair using AM-2 matting (three craters).	Repair consists of the following: (1) Remove fractured pavement around craters, (2) replace and compact ejecta in craters, (3) place and compact select fill on ejecta, (4) place AM-2 surfacing over filled craters, (5) anchor surfacing to existing pavement. Three AM-2 landing mat repair kits are furnished in facility. Each kit will surface a 4,185-square-foot area.
Airfield pavements: runways, taxiway, or apron	Three 50-foot-diameter craters were caused by 750-lb bombs.	11150AG	Bomb damage repair to U.S. Air Force runways, taxiways, and aprons (three craters) 1,260 square yard.	Repair consists of the same procedure as listed for facility no. 11150AF, except that British class 60 trackway is substituted for the AM-2 landing mat. Sections of trackway 52.4-foot-wide by 72-foot-long are furnished in bundles that are 52.4 feet wide and have a diameter of 4.1 feet.
Fixed-position refueling station for aircraft	Refueling station was completely destroyed.	12110AB	Bomb damage repair of aircraft fuel-dispensing facilities.	The refueling system is replaced with a self-contained module that consists of a pump unit and two 50,000-gallon collapsible tanks.
50,000-barrel POL storage tank	Storage tank was completely destroyed.	12110AE	Bomb damage repair of POL storage facilities.	The damaged facility is replaced with bladder-type tanks at a new location.
8-inch-diameter POL pipeline	200 linear feet were destroyed.	12520AA	Bomb damage repair of POL Pipeline, 8-inch.	The 200 feet of damaged pipeline are removed and replaced with new pipe.
6-inch-diameter POL pipeline	200 linear feet were destroyed.	12520AB	Bomb damage repair of POL pipeline, 6-inch.	The 200 feet of damaged pipeline are removed and replaced with new pipe.
4-inch-diameter POL pipeline	200 linear feet were destroyed.	12520AC	Bomb damage repair of POL pipeline, 4-inch.	The 200 feet of damaged pipeline are removed and replaced with new pipe.
Runway lighting system	The runway lighting system was destroyed, or a lighting system is required for a temporary runway.	13610AA	Bomb damage repair to airfield runway lighting.	The facility provides an expedient lighting system for 8,000 linear feet of runway or taxiway lighting. If necessary, the system will require two 30-kW ac generators (NSN 6115-00-118-1240).
Aircraft revetment	Total or partial destruction of aircraft revetment.	14910AA	Bomb damage repair of revetments.	The facility provides materials for construction of 384 linear feet of steel bin-type revetment walls. 1,920 cubic feet of local earth fill are required. Design of the facility permits flexibility of its final configuration.
Aircraft arresting barrier	Arresting barrier system was destroyed.	14920AA	Bomb damage repair of aircraft arresting barrier.	The facility contains a BAK-12 arresting barrier that includes an engaging device and energy absorbers.

DAMAGED FACILITY	DESCRIPTION OF DAMAGE	FACILITY NO.	TITLE	REMARKS
1,200-foot-long by 90-foot-wide commercial cargo pier (wood piles, wood deck)	Three 750-lb bombs hit the pier, with damage as follows: (1) A 100-foot by 50-foot section located on port side was completely destroyed, (2) a 110-foot by 50-foot section located at the end on the starboard side was completely destroyed, (3) a 100-foot-diameter section located in the center was completely destroyed.	15150AD	Bomb damage repair to a commercial cargo pier.	The destroyed sections located on the port and starboard side are cleaned of debris and barricaded to prevent accidents. The center section is cleaned of debris, and two bailey bridges are erected across the gap to provide simultaneous traffic in two directions.
1,200-foot-long by 70-foot-wide wharf constructed on wood piles and decked with reinforced concrete	Three 750-lb bombs hit the wharf, with damage as follows: (1) A 50-foot-diameter area located in the center of the wharf was completely destroyed, (2) two 50-foot-diameter areas located on the far shore were destroyed. Varying degrees of destruction also occurred up to 1,000 feet from where the bombs exploded.	15250AU	Bomb damage repair of cargo wharf.	Debris is removed from the wharf. Barriers and curbing are placed around the destroyed areas to prevent accidents. New dolphins are driven at each end of the wharf to replace the damaged dolphins.
400-foot-long vehicle-bridge over a river	Bridge was completely destroyed.	85120KR	Bomb damage repair of bridge over a 300- to 400-foot-wide river: Replace with ribbon bridge (includes approaches) 400-foot gap.	A floating ribbon bridge is constructed to replace the bomb-damaged bridge.
110-foot-long vehicle-bridge over a river or ravine	Bridge was completely destroyed.	85120KT	Bomb damage repair of a fixed bridge, 110-foot gap or less.	A double single-lane bailey bridge is used to replace the bomb-damaged bridge.
Single-track railroad system	Damage consists of a 25-foot-diameter 10-foot-deep crater, with approximately 50 linear feet of railroad track damaged on each side of the crater.	86010AD	Bomb damage repair of single-track railroad system. Damage is one crater (25 feet) plus twisted track for 50 feet on each side of crater.	Debris is removed from the area, ejecta is replaced and compacted into the crater, and new ties and tracks are installed.
Single-track railroad bridge	A 40-foot-long span of the bridge and substructure was destroyed.	86030TP	Bomb damage repair to a railroad bridge, one 40-foot four-beam span and one 30-foot pier.	Assume that the abutments and pier foundations did not receive significant damage. Repair consists of the following: (1) Clear site of debris, (2) construct 30-foot pier, (3) erect 40-foot-span section, (4) lay ties and rails.

## APPENDIX D CLIMATIC CONDITIONS

### D-1. EXPLANATION OF CLIMATIC TERMS

*a. Climatic Zones.* The four climatic zones considered in AFCS facility designs.

- (1) Temperate Zone.
- (2) Tropical Zone.
- (3) Frigid Zone.
- (4) Desert Zone.

*b. Climatic Categories.* Eight broad classes<sup>1</sup> of climate differentiated on the basis of temperature and/or humidity extremes. Climatic conditions of each climatic zone are detailed in paragraphs D-2 through D-5 and are summarized in table D-1. Interrelationships of climatic zones and climatic categories for the purposes of AFCS designs are:

- (1) *Temperate Zone.*
  - (a) Category 5: Intermediate Hot-Dry.
  - (b) Category 6: Intermediate Cold.
- (2) *Tropical Zone.*
  - (a) Category 1: Wet-Warm.
  - (b) Category 2: Wet-Hot.
- (3) *Frigid Zone.* Category 7: Cold.
- (4) *Desert Zone.*
  - (a) Category 3: Humid-Hot Coastal Desert.
  - (b) Category 4: Hot-Dry.

*c. Operational and Storage and Transit Conditions.* The distinction made between operational temperature and humidity conditions and storage and transit temperature and humidity conditions.

(1) *Operational Conditions.* The climatic conditions to which military materiel might be subjected during operations or standby for operations. Determined in accordance with the 1-percent risk policy,<sup>2</sup> operational conditions are stated in terms of ambient temperature and

humidity measured under standard conditions of ventilation and radiation shielding in a meteorological shelter 4 to 6 feet above the ground. Solar radiation and wind values that might be experienced concurrently with the temperature and humidity also are set forth for many of the categories. Temperature of the materiel itself may vary considerably from the operational air temperature because of the effects of incoming and outgoing radiation, internal sources of heat, thermal mass, and heat transfer characteristics of the materiel.

(2) *Storage and Transit Conditions.* Air temperature and humidity conditions to which materiel might be subjected in storage and transit situations. Examples are the inside of an ISO container or unventilated field storage shelter, under a tarpaulin, in a tent, or in a railway box-car. Storage and transit air temperature and humidity may differ from operational temperature and humidity because of induced effects of heat gain or air loss in confined spaces.

### D-2. TEMPERATE ZONE: INTERMEDIATE HOT-DRY AND INTERMEDIATE COLD

*a. Category 5: Intermediate Hot-Dry.*

(1) *Location.* Intermediate hot-dry conditions are found throughout the world, extending outward from the areas of hot-dry conditions in the United States, Mexico, Africa, Asia, and Australia. Intermediate hot-dry conditions are also found in southern Africa, South America, southern Spain, and Southeast Asia during the dry seasons.

(2) *Operational Conditions.*

(a) Four hours with an ambient air temperature above 105 °F, with an extreme temperature of 110 °F for not more than 1 hour.

(b) A maximum ground surface temperature of 130 °F.

1. Category 8, Extreme Cold, is not used for AFCS design criteria.

2. AFCS designs are developed to withstand the most extreme climatic conditions only 1-percent of the time (hours) in the most extreme month in the most extreme parts of the climatic area. The 1-percent risk policy is used in order to avoid the cost and complexity of designing for absolute conditions.

Table D-1. Summary of temperature, solar radiation, and relative humidity extremes

	Desert Zone		Frigid Zone	Temperate Zone		Tropical Zone	
	Category 3 Hot-Humid Coastal Desert	Category 4 Hot-Dry	Category 7 Cold	Category 5 Intermediate Hot-Dry	Category 6 Intermediate Cold	Category 1 Wet-Warm	Category 2 Wet-Hot
<b>Operational Conditions</b>							
Ambient Air Temperature °F	85 to 110	90 to 160	-35 to 50	70 to 110	-5 to -25	75	78 to 95
Reverse Season Air Temperature °F	32	25	95	NA	NA	40	40
Solar Radiation Btu/ft <sup>2</sup> /hr	0 to 360	0 to 360	Negligible	0 to 360	Negligible	Negligible	0 to 360
Ambient Relative Humidity %	63 to 90	5 to 20	Tending toward saturation	20 to 85	Tending toward saturation	95 to 100	74 to 100
<b>Storage &amp; Transit Conditions</b>							
Induced Air Temperature °F	90 to 160	90 to 160	-35 to -50	20 to 145	-10 to -35	80	90 to 160
Induced Relative Humidity %	10 to 85	2 to 50	Tending toward saturation	5 to 50	Tending toward saturation	95 to 100	10 to 85

(c) Solar radiation (horizontal surface) at a rate of 360 Btu/ft<sup>2</sup>/hr for not more than 4 hours.

(d) A wind velocity between 5 and 10 knots when temperatures are above 105 °F.

(3) *Storage and Transit Conditions.* Four continuous hours occur with an induced air temperature above 140 °F and relative humidity less than 10 percent; an air temperature extreme of 145 °F occurs for not more than 1 hour without benefit of solar radiation and with negligible wind.

(4) *Rain.* A 12-hour rainfall of 9.5 inches occurs with a maximum intensity of 0.45 inches per minute and an intermittent wind velocity of 35 knots.

(5) *Snow.* Snow occurs in part of the area designated intermediate, but not during periods of high temperature.

(6) *Icing.* Icing occurs in parts of the area designated intermediate, but not during periods of high temperature.

(7) *Sea-Salt Fallout.* The distribution of sea-salt fallout is uneven over land areas with maximum amounts on exposed coasts and minimum amounts in dry inland areas. For inland deserts, sea salts may be supplemented by local alkali suspensions. Fallout can be locally intense, although most dry inland areas experience less than 5 lb/acre/yr. Even in the dry interior of North America and Eurasia a few areas experience salt fallout of less than 0.5 lb/acre/yr.

(8) *Winds.* AFCS designs with a life expectancy of 5 years or more may be subject to winds of 55 knots (with gusts to 85 knots) for a 5-minute period, except at exposed coastal and mountain locations where sustained 5-minute winds of 70 knots with gusts to 105 knots may be experienced. Designs with a life expectancy of less than 5 years, may be subject to winds of 45 knots (with gusts to 65 knots) for a 5-minute period. All wind velocities were determined for a height of 10 feet above the ground.

(9) *Blowing Sand.* Blowing sand is considered when winds are greater than 30 knots. Windblown particles are 0.01 to 1.00 mm in diameter, with predominant diameters between 0.15 and 0.3 mm found close to the surface and approximately half the particles below 0.4 mm and a few particles above 4 mm. Sand stirred up by aircraft or vehicles may produce heavier concentrations at higher levels.

(10) *Blowing Dust.* Windblown dust concentrations are  $6 \times 10^{-9}$  gm/cm<sup>3</sup> with a 0.0001 to 0.01 mm diameter and blow at 35 knots at a 5-foot height. Dust stirred up by aircraft or vehicles may produce heavier concentrations.

(11) *Atmospheric Pressure.*

(a) Sea Level Maximum: 1,050 millibars (31.0 inches of mercury).

(b) Sea Level Minimum: 990 millibars (29.2 inches of mercury).

b. *Category 6: Intermediate Cold.*

(1) *Location.* Intermediate cold conditions are found only in the Northern Hemisphere in midlatitudes south of the coldest areas and on high-latitude coasts (such as the southern coast of Alaska) where maritime effects prevent very low temperatures.

(2) *Operational Conditions.*

(a) Six continuous hours with an ambient air temperature of -25 °F.

(b) A minimum ground surface temperature of -35 °F.

(c) Wind velocity less than 10 knots.

(d) Negligible solar radiation (horizontal surface).

(e) Humidity tending toward saturation.

(f) Wind velocities infrequently greater than 10 knots with temperatures of -25 °F.

(3) *Storage and Transit Conditions.* Six continuous hours occur with an induced air temperature of -30 °F and no wind or solar radiation; humidity tends toward saturation.

(4) *Rain.* Not applicable during periods of low temperature extremes.

(5) *Snow Load.* 30 lb/ft<sup>2</sup>.

(6) *Icing.* Deposits of hoarfrost, rime, and glaze may be several inches thick.

(7) *Sea-Salt Fallout.* Near windward coasts (i.e., southern coast of Alaska), sea-salt fallout of 25 lb/acre/yr or more may occur. In the continental interiors, sea-salt fallout is normally between 3 and 5 lb/acre/yr.

(8) *Winds.* See category 5, intermediate hot-dry.

(9) *Blowing Sand.* See category 5, intermediate hot-dry.

(10) *Blowing Dust*. See category 5, intermediate hot-dry.

(11) *Atmospheric Pressure*.

(a) Sea Level Maximum: 1,055 millibars (31.2 inches of mercury).

(b) Sea Level Minimum: 960 millibars (28.3 inches of mercury).

### D-3. TROPICAL ZONE: WET-WARM AND WET-HOT

a. *Category 1: Wet-Warm*.

(1) *Location*. Wet-warm conditions are found under the canopy of heavily forested tropical areas. In part of the area, wet-warm conditions may occur on several days during any month of the year (nonseasonal); however, in the rest of the area, wet-warm conditions may occur seasonally, but on several days in at least 4 months of the year.

(2) *Operational Conditions*. Persistence of relative humidity above 95 percent with nearly constant temperatures of 75 °F for periods of a day or more.

(3) *Storage and Transit Conditions*. Persistence of relative humidity above 95 percent with temperatures of nearly 80 °F for periods of a day or more.

(4) *Rain*. Rainfall is intercepted by the forest canopy and reaches the forest floor as drip and tree runoff.

(5) *Sea-Salt Fallout*. Negligible.

(6) *Winds*. Wind beneath the forest canopy is light, seldom exceeding 5 knots.

(7) *Atmospheric Pressure*.

(a) Sea Level Maximum: 1,030 millibars (30.4 inches of mercury).

(b) Sea Level Minimum: 945 millibars (27.9 inches of mercury).

(9) *Reverse Season Temperature*. The reverse season minimum temperature expectancy is 40 °F. That temperature is in accordance with the 1-percent risk policy.

b. *Category 2: Wet-Hot*.

(1) *Location*. Wet-hot conditions, characterized by high temperatures accompanied by high humidity and intense solar radiation, are found in open, tropical areas. Those are the same general areas where category 1 (wet-

warm conditions) are found, but in the open rather than under the forest canopy. In part of the area, wet-hot conditions may be experienced during any month of the year, while in the rest of the area wet-hot conditions occur seasonally at least 4 months per year.

(2) *Operational Conditions*.

(a) Four continuous hours with an ambient temperature of 95 °F.

(b) Maximum ground surface temperature of 130 °F.

(c) Maximum solar radiation (horizontal surface) at a rate of 360 Btu/ft<sup>2</sup>/hr for not more than 4 hours.

(d) A wind velocity less than 5 knots, concurrent with the high temperatures.

(e) Relative humidity of 74 percent, concurrent with the high temperatures.

(3) *Storage and Transit Conditions*.

(a) Four continuous hours with an induced air temperature above 155 °F.

(b) Relative humidity between 10 and 20 percent.

(c) An air temperature extreme of 160 °F for not more than 1 hour without benefit of solar radiation and negligible wind.

(4) *Rain*. See category 5, intermediate hot-dry.

(5) *Sea-Salt Fallout*. Salt fallout will vary from a maximum of over 25 lb/acre/yr on exposed coasts to a minimum between 3 and 5 lb/acre/yr at inland locations.

(6) *Winds*. See category 5, intermediate hot-dry.

(7) *Blowing Sand*. Not applicable during wet periods that characterize the wet-hot category; however, blowing sand may be a problem during the dry seasons and even during dry spells in the wet season. See category 5, intermediate hot-dry.

(8) *Atmospheric Pressure*.

(a) Sea Level Maximum: 1,030 millibars (30.4 inches of mercury).

(b) Sea Level Minimum: 945 millibars (27.9 inches of mercury).

(9) *Reverse Season Temperature*. The reverse season minimum temperature expectancy is 40 °F. That temperature is in accordance with the 1-percent risk policy.



**D-4. FRIGID ZONE: COLD**

*a. Location.* Cold conditions (category 7) are found only in the Northern Hemisphere in Canada, Alaska, Greenland, northern Scandinavia, northern Asia, Tibet, and Russia.

*b. Operational Conditions.*

(1) Six continuous hours with a minimum ambient air temperature of -50 °F.

(2) A minimum ground or snow surface temperature of -50 °F.

(3) Wind velocity of less than 10 knots.

(4) Negligible solar radiation (horizontal surface).

(5) Humidity tending toward saturation.

*c. Reverse Season Temperature.* The reverse season maximum temperature expectancy is 95 °F. That temperature is in accordance with the 1-percent risk policy.

*d. Storage and Transit Conditions.* Same as operational conditions.

*e. Rain.* Not applicable during periods of low temperature extremes.

*f. Snow Load.* 60 lb/ft<sup>2</sup>.

*g. Icing.*

(1) *Hoarfrost.* Hoarfrost can occur only under cold conditions. Deposits may be several inches thick.

(2) *Ice Fog.* Suspended ice crystals average 5 to 20 microns in diameter. In areas where there is a source of water vapor, ice fog occurs mainly at temperatures below -20 °F; when temperatures are below -35 °F, ice fog may be very dense, limiting visibility to a few feet.

*h. Sea-Salt Fallout.* Generally, less than 3 lb/acre/yr because of the low salinity of northern waters and the interior location of most areas where cold conditions occur.

*i. Wind.* See category 5, intermediate hot-dry.

*j. Blowing Sand.* See category 5, intermediate hot-dry.

*k. Blowing Dust.* See category 5, intermediate hot-dry.

*l. Atmospheric Pressure.*

(1) Sea Level Maximum: 1,060 millibars (31.3 inches of mercury).

(2) Sea Level Minimum: 970 millibars (28.6 inches of mercury).

**D-5. DESERT ZONE: HUMID-HOT COASTAL DESERT AND HOT-DRY**

*a. Category 3: Humid-Hot Coastal Desert.*

(1) *Locations.* Humid-hot coastal desert conditions are limited to the immediate coast of bodies of water having a high surface temperature, such as the Persian Gulf and the Red Sea. Those coastal areas have the highest water vapor associated with air near the ground.

(2) *Operational Conditions.*

(a) Not more than 4 continuous hours with an ambient air temperature of 100 °F. Temperatures higher than 100 °F can occur in humid-hot coastal desert.

(b) Relative humidity 64 percent, corresponding to a wet bulb temperature of 89 °F and a dew point temperature of 86 °F.

(c) Maximum ground temperature of 130 °F.

(d) Maximum solar radiation (horizontal surface) at a rate of 360 Btu/ft<sup>2</sup>/hour for not more than 4 hours.

(e) Wind velocities between 5 and 10 knots.

(3) *Storage and Transit Conditions.* Not more than 4 continuous hours with an induced air temperature above 155 °F and relative humidity less than 5 percent; an air temperature extreme of 160 °F for not more than 1 hour without benefit of solar radiation and with negligible wind.

(4) *Reverse Season Temperature.* The reverse season minimum temperature expectancy is 32 °F. That temperature is in accordance with the 1-percent risk policy.

(5) *Rain.* A 1-hour rainfall of 4.00 inches, with a maximum intensity of 0.45 inches per minute and an intermittent wind velocity of 35 knots. The total annual inches and frequency of rainfall are much less in the humid-hot and hot-dry climates than in the wet-warm, wet-hot, and intermediate climates; nevertheless, heavy rainfall may fall occasionally in parts of the humid-hot areas. Temperatures during heavy rainfall are lower than 80 °F.

(6) *Sea-Salt Fallout.* Salt fallout is no more than 25 lb/acre/yr.

(7) *Winds.* See category 5, intermediate hot-dry.

(8) *Blowing Sand.* See category 5, intermediate hot-dry.

(9) *Blowing Dust.* See category 5, intermediate hot-dry.

(10) *Atmospheric Pressure.*

(a) Sea Level Maximum: 1,030 millibars (30.4 inches of mercury).

(b) Sea Level Minimum: 990 millibars (29.2 inches of mercury).

b. *Category 4: Hot-Dry.*

(1) *Location.* Hot-dry conditions are found in the deserts of northern Africa, the Middle East, West Pakistan, India, southwestern United States, and northern Mexico and Australia.

(2) *Operational Conditions.*

(a) Four continuous hours with an ambient temperature above 120 °F. An extreme temperature of 125 °F for not more than 1 hour. A maximum ground surface temperature of 145 °F.

(b) Solar radiation (horizontal surface) at a rate of 350 Btu/ft<sup>2</sup>/hr concurrent with a temperature above 120 °F.

(c) Wind velocities between 5 and 10 knots during the period with temperatures above 120 °F.

(d) A relative humidity of approximately 5 percent concurrent with the high temperature.

(3) *Storage and Transit Conditions.* Not more than 4 continuous hours with an induced air temperature above 155 °F and relative humidity less than 5 percent; an air temperature extreme of 160 °F for not more than 1 hour without benefit of solar radiation and with negligible wind.

(4) *Reverse Season Temperature.* The reverse season minimum temperature expectancy is 25 °F. That temperature is in accordance with the 1-percent risk policy.

(5) *Rain.* See category 5, intermediate hot-dry.

(6) *Sea-Salt Fallout.* See category 5, intermediate hot-dry.

(7) *Winds.* See category 5, intermediate hot-dry.

(8) *Blowing Sand.* See category 5, intermediate hot-dry.

(9) *Blowing Dust.* See category 5, intermediate hot-dry.

(10) *Atmospheric Pressure.*

(a) Sea Level Maximum: 1,040 millibars (30.7 inches of mercury).

(b) Sea Level Minimum: 985 millibars (29.1 inches of mercury).

## APPENDIX E ENGINEERING CAPABILITY TABLES

*Table E-1. Equipment assumptions, engineer battalion (combat heavy)*

ENGINEER LINE COMPANY*		
EQUIPMENT CATEGORY	EQUIPMENT	LINE ITEM NO.
Lift/load	25-ton crane (1)	F43429
Grading	Grader (3)	G74783
Compacting	Pneumatic roller (1)	S11793
	Vibratory roller (1)	S12916
	Sheepsfoot roller, SP (1)	E61618
Hauling	Scraper (4)	S56246
	5-ton dump truck (6)	X43708
Excavating	Dozer, ME (3)	W83529
	Dozer, ME (2)	W76816
	Scoop loader (2)	L76556
	Backhoe (2)	W91074
HEADQUARTERS AND SUPPORT COMPANY**		
EQUIPMENT CATEGORY	EQUIPMENT	LINE ITEM NO.
Lift/load	12-1/2-ton shovel (1)	F43364
Compacting	Roller, steel wheel (1)	S11711
	Roller, pneumatic (2)	S11793
Hauling	20-ton dump truck (9)	X44403
Excavating	5-cubic -yard scoop loader (2)	L76321
	Dozer, HV (3)	W88575
	Dozer, HV (3)	W88699
Concrete Mixing	8-cubic-yard concrete truck (3)	T42725
Bitumen Distribution	Tank truck (2)	G27844

\*Each engineer line company in the battalion contains the productive equipment listed (for AFCS estimating purposes).  
 \*\*The engineer support company in the battalion contains the productive equipment listed (for AFCS estimating purposes).

Table E-2. Engineer unit capability table, engineer battalion (combat heavy) 5-415L

	NO. OF PERSONNEL	MAN-HOURS/DAY*
TOTAL UNIT STRENGTH	634	-
VERTICAL CONSTRUCTION SKILLS:		
Carpenter/Mason	72	720
Electrician	18	180
Plumber/Pipe Fitter	18	180
Metal Worker/Welder	-	-
EFFECTIVE VERTICAL MAN-HOURS/DAY	-	1,080
	PIECES OF EQUIPMENT	EQUIPMENT-HOURS/DAY*
HORIZONTAL CONSTRUCTION EQUIPMENT:		
Lift/load Equipment	6	60
Grading Equipment	9	90
Compaction Equipment	12	120
Hauling Equipment	39	390
Excavation Equipment	32	320
Concrete Mobile Equipment	3	30
Bitumen Distributor Equipment	2	20
Asphalt Paving/Rolling Equipment	-	-
EFFECTIVE HORIZONTAL MAN-HOURS/DAY	-	1,030

\*Productive man/equipment hours per 10-hour day.

*Table E-3. Engineer unit capability table, headquarters and support company engineer battalion (combat heavy) 5-416L*

	NO. OF PERSONNEL	MAN-HOURS/DAY*
TOTAL UNIT STRENGTH	217	-
VERTICAL CONSTRUCTION SKILLS:		
Carpenter/Mason	-	-
Electrician	-	-
Plumber/Pipe Fitter	-	-
Metal Worker/Welder	-	-
EFFECTIVE VERTICAL MAN-HOURS/DAY	-	-
	PIECES OF EQUIPMENT	EQUIPMENT-HOURS/DAY*
HORIZONTAL CONSTRUCTION EQUIPMENT:		
Lift/load Equipment	3	30
Grading Equipment	-	-
Compaction Equipment	3	30
Hauling Equipment	9	90
Excavation Equipment	8	80
Concrete Mobile Equipment	3	30
Bitumen Distributor Equipment	2	20
Asphalt Paving/Rolling Equipment	-	-
EFFECTIVE HORIZONTAL MAN-HOURS/DAY	-	280

\*Productive man/equipment hours per 10-hour day.

*Table E-4. Engineer unit capability table ,  
headquarters and support company engineer battalion (combat heavy) 5-417L*

	NO. OF PERSONNEL	MAN-HOURS/DAY*
TOTAL UNIT STRENGTH	139	-
VERTICAL CONSTRUCTION SKILLS:		
Carpenter/Mason	24	240
Electrician	6	60
Plumber/Pipe Fitter	6	60
Metal Worker/Welder	-	-
EFFECTIVE VERTICAL MAN-HOURS/DAY	-	360
	PIECES OF EQUIPMENT	EQUIPMENT-HOURS/DAY*
HORIZONTAL CONSTRUCTION EQUIPMENT:		
Lift/load Equipment	1	10
Grading Equipment	3	30
Compaction Equipment	3	30
Hauling Equipment	10	100
Excavation Equipment	8	80
Concrete Mobile Equipment	-	-
Bitumen Distributor Equipment	-	-
Asphalt Paving/Rolling Equipment	-	-
EFFECTIVE HORIZONTAL MAN-HOURS/DAY	-	250

\*Productive man/equipment hours per 10-hour day.

Table E-5. Engineer unit capability table, engineer company pipeline construction 5-434L

	NO. OF PERSONNEL	MAN-HOURS/DAY*
TOTAL UNIT STRENGTH	153	-
VERTICAL CONSTRUCTION SKILLS:		
Carpenter/Mason	33	330
Electrician	-	-
Plumber/Pipe Fitter	18	180
Metal Worker/Welder	9	90
EFFECTIVE VERTICAL MAN-HOURS/DAY	-	600
	PIECES OF EQUIPMENT	EQUIPMENT-HOURS/DAY*
HORIZONTAL CONSTRUCTION EQUIPMENT:		
Lift/load Equipment	5	50
Grading Equipment (Dozer)	2	20
Compaction Equipment	-	-
Hauling Equipment	-	-
Excavation Equipment	3	30
Concrete Mobile Equipment	-	-
Bitumen Distributor Equipment	-	-
Asphalt Paving/Rolling Equipment	-	-
EFFECTIVE HORIZONTAL MAN-HOURS/DAY	-	100

\*Productive man/equipment hours per 10-hour day.

Table E-6. Engineer unit capability table, engineer company port construction 5-603L

	NO. OF PERSONNEL	MAN-HOURS/DAY*
TOTAL UNIT STRENGTH	206	-
VERTICAL CONSTRUCTION SKILLS:		
Carpenter/Mason	24	240
Electrician	6	60
Plumber/Pipe Fitter	4	40
Metal Worker/Welder	10	100
EFFECTIVE VERTICAL MAN-HOURS/DAY	-	440
	PIECES OF EQUIPMENT	EQUIPMENT-HOURS/DAY*
HORIZONTAL CONSTRUCTION EQUIPMENT:		
Lift/load Equipment (including pile driving)	7	70
Grading Equipment	1	10
Compaction Equipment	-	-
Hauling Equipment	4	40
Excavation Equipment	4	40
Concrete Mobile Equipment	1	10
Bitumen Distributor Equipment	-	-
Asphalt Paving/Rolling Equipment	-	-
EFFECTIVE HORIZONTAL MAN-HOURS/DAY	-	170

\*Productive man/equipment hours per 10-hour day.



Table E-7. Engineer unit capability table, engineer company dump truck 5-424L

	NO. OF PERSONNEL	MAN-HOURS/DAY*
TOTAL UNIT STRENGTH	78	-
VERTICAL CONSTRUCTION SKILLS:		
Carpenter/Mason	-	-
Electrician	-	-
Plumber/Pipe Fitter	-	-
Metal Worker/Welder	-	-
EFFECTIVE VERTICAL MAN-HOURS/DAY	-	-
	PIECES OF EQUIPMENT	EQUIPMENT-HOURS/DAY*
HORIZONTAL CONSTRUCTION EQUIPMENT:		
Lift/load Equipment	-	-
Grading Equipment	-	-
Compaction Equipment	-	-
Hauling Equipment	30	300
Excavation Equipment	-	-
Concrete Mobile Equipment	-	-
Bitumen Distributor Equipment	-	-
Asphalt Paving/Rolling Equipment	-	-
EFFECTIVE HORIZONTAL MAN-HOURS/DAY	-	300

\*Productive man/equipment hours per 10-hour day.

Table E-8. Engineer unit capability table, engineer company construction support 5-413L

	NO. OF PERSONNEL	MAN-HOURS/DAY*
TOTAL UNIT STRENGTH	161	-
VERTICAL CONSTRUCTION SKILLS:		
Carpenter/Mason	-	-
Electrician	-	-
Plumber/Pipe Fitter	-	-
Metal Worker/Welder	-	-
EFFECTIVE VERTICAL MAN-HOURS/DAY	-	-
	PIECES OF EQUIPMENT	EQUIPMENT-HOURS/DAY*
HORIZONTAL CONSTRUCTION EQUIPMENT:		
Lift/load Equipment	-	-
Grading Equipment	-	-
Compaction Equipment	-	-
Hauling Equipment	-	-
Excavation Equipment	-	-
Concrete Mobile Equipment	-	-
Bitumen Distributor Equipment	-	-
Asphalt Paving/Rolling Equipment	7	70
EFFECTIVE HORIZONTAL MAN-HOURS/DAY	-	70

\*Productive man/equipment hours per 10-hour day.

## APPENDIX F

### CONSTRUCTION DRAWINGS

---

#### F-1. PURPOSE

Working drawings and planning information are the main sources of facts for those responsible for construction work. The construction drawings graphically represent details of the structure to be built and the construction site layout. The planning information identifies the materials, personnel, and equipment to be used and the work sequence to be followed during construction. This appendix briefly describes for the nonengineer construction drawings and their uses.

#### F-2. TYPES OF DRAWINGS.

A drawing set includes general drawings, such as site plans, floor plans, elevations, and isometric views. Also included are detailed drawings, such as sectional views and construction details.

*a. Site Plan.* A site plan (see figure F-1) shows property lines and locations, building lines, locations of structures to be built, existing structures, and approach and access roads. A site plan provides actual dimensions of the site and shows scale representations of the facilities. Figure F-2 shows a corresponding site electrical plan. Since AFCS installation layouts are designed for general worldwide application, no specific information such as site orientation (north arrow) or slope and terrain (contour lines) is shown. Therefore, a site analysis must consider the criteria listed in (1) through (5) below:

(1) *Slope.* Contour lines show the elevation of the earth's surface above or below the elevation of a known and permanent reference point (benchmark). Since all points along the line are at the same elevation, the arrangement of the contour lines indicates if parts of the site are suitable for construction. For example, it would be unwise to put habitable buildings in an area where runoff water is likely to collect. Similarly, recreation areas or athletic courts should not be located on ground that is sloped more steeply than the recommended maximum.

(2) *Site Access.* Factors such as existing approach roads, terrain, and security maintenance should be considered when locating entry and access points to the site.

(3) *Existing Vegetation.* Site preparation can waste time and resources if not handled carefully. If exist-

ing vegetation patterns are considered, buildings can often be placed in natural clearings, eliminating clearing efforts. Furthermore, careful site planning can help minimize environmental damage caused by construction operations, and indigenous plants can be an economical and effective source of camouflage materials. Trees and bushes can also provide effective windbreaks as well as solar shading in hot climates.

(4) *Climatic Orientation.* Consideration of solar orientation and prevailing winds can lead to more effective placement of buildings. In the temperate and cold climates of the Northern Hemisphere, buildings are best placed on southerly slopes and oriented with their longest face toward the south. That orientation allows maximum passive use of solar heat, which conserves fuel and makes the structures more livable. Consideration of prevailing winds can also be important. Hillcrests are generally much windier than hillsides; therefore, in warm climates, it would be best to locate buildings at the high point; in a cold climate, it would be most beneficial to locate buildings on the slopes. (See figure 2-1.)

(5) *Site Plan Summary.* Since AFCS installations must be designed for worldwide application, construction for a specific site may be modified somewhat. Topographic and climatological maps of the proposed site should be consulted and a site analysis should be performed so that suitable adaptations can be made. The dimensions and relationships indicated on installation site plans are merely guidelines for planning; they should be changed when there is a better option for a specific site.

*b. Elevation and Isometric Views.* Elevation views (see figure F-3) are drawings that show the front, rear, or side view of a building or other structure. Construction materials are usually noted on the drawings, as are prominent features such as doors, windows, foundation footings, and ventilators. An elevation primarily describes the vertical relationship between building components; either vertical dimensions or elevations above a known point (usually a floor) will appear in the drawing. Isometric views (see figure F-4) sometimes show a building or structure more realistically because as three-dimensional diagrams they combine two elevations (and

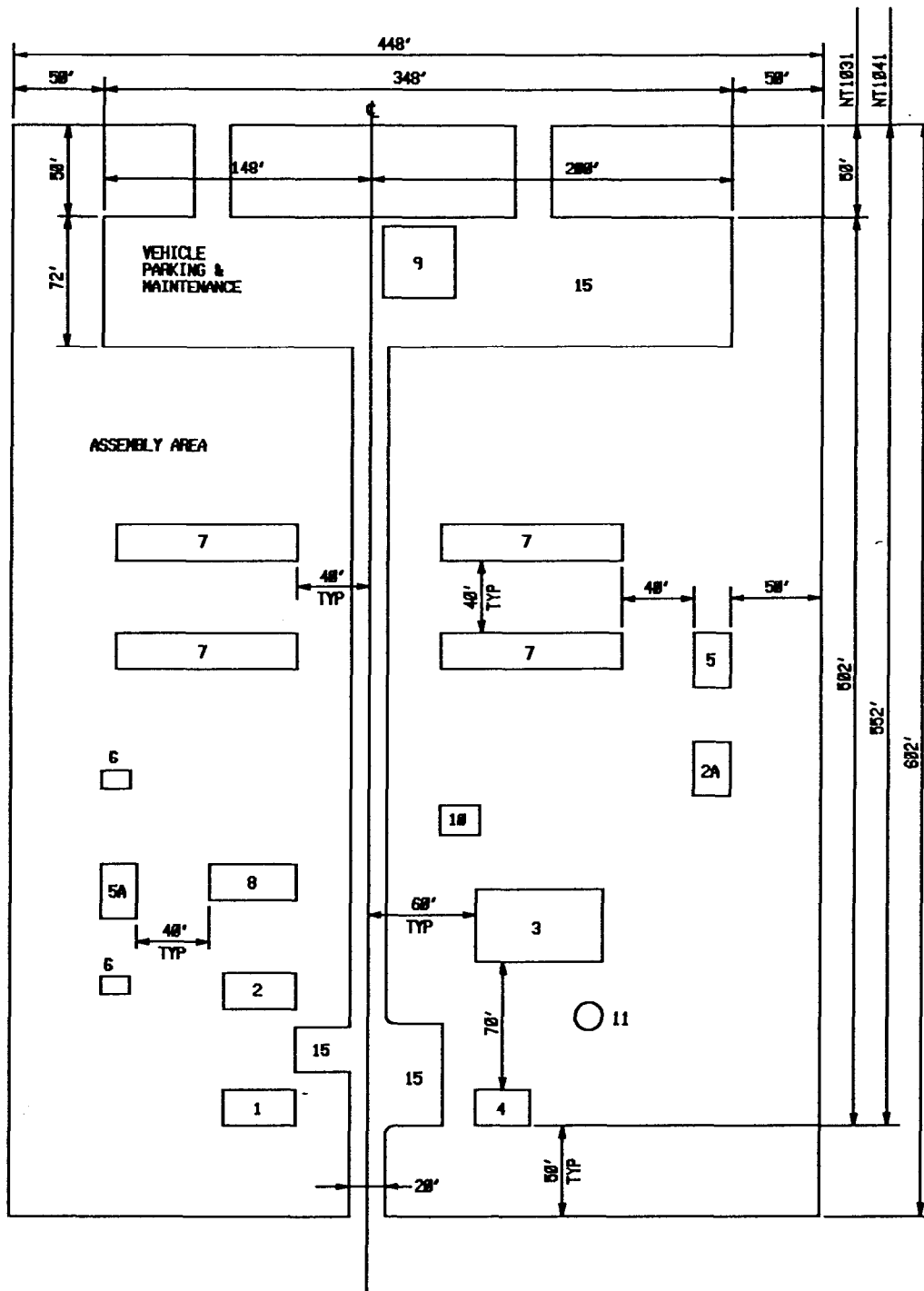

SITE LAYOUT  
 125-MAN TROOP CAMP  
 INSTALLATION NO. NT 1031 W/MOTOR POOL  
 INSTALLATION NO. NT 1041 W/O MOTOR POOL  
TEMPORARY STANDARD

Figure F-1. Typical site plan

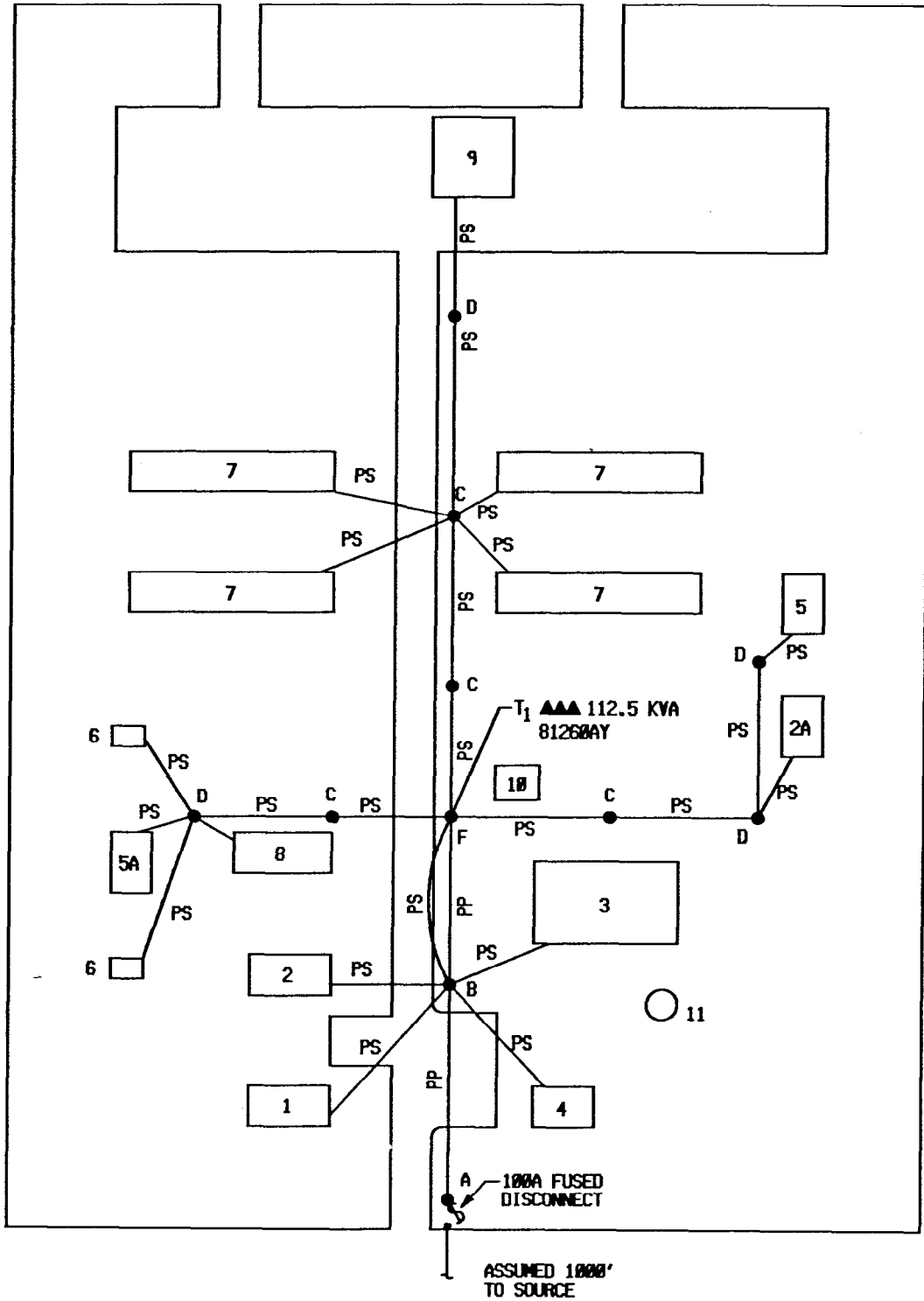

ELECTRICAL PLAN - 81240HA

Figure F-2. Typical electrical plan

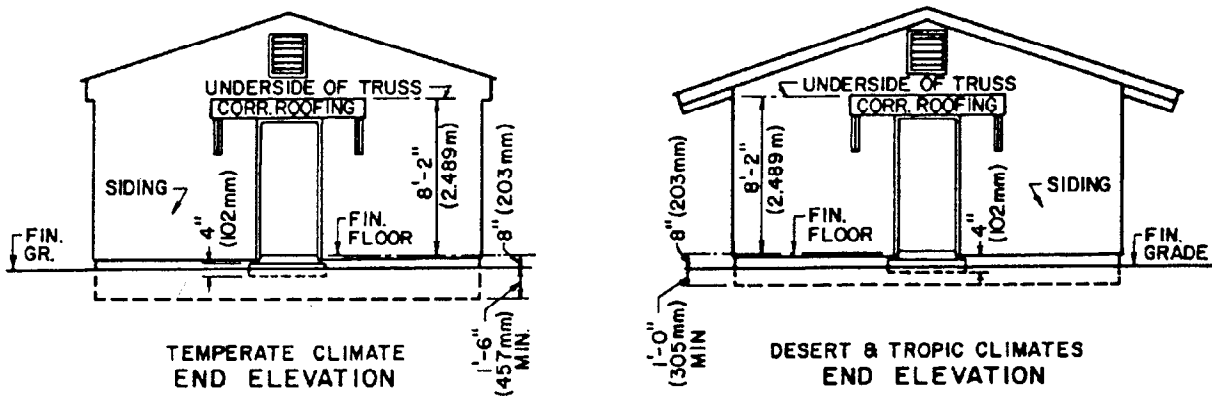
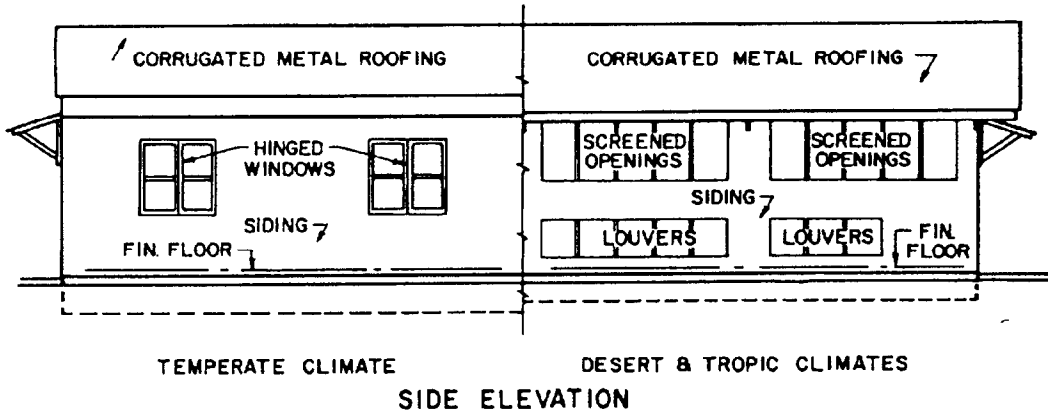
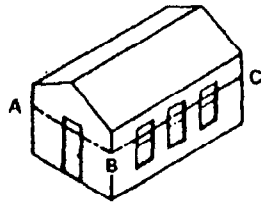
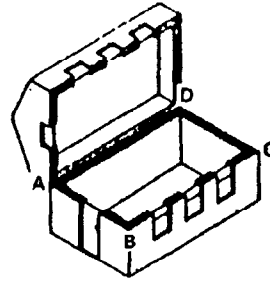

Figure F-3. Elevation views



PERSPECTIVE VIEW OF A  
SIMPLE BUILDING SHOWING  
CUTTING PLANE ABC



PREVIOUS PERSPECTIVE VIEW AT  
CUTTING PLANE ABCD,  
HINGED AND TOP LAID BACK

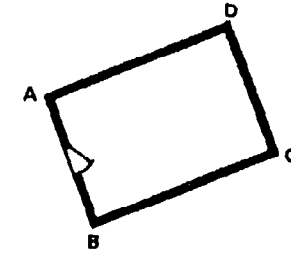

DEVELOPED FLOOR PLAN  
ABCD

PLAN DEVELOPMENT — SIMPLE BUILDING

1

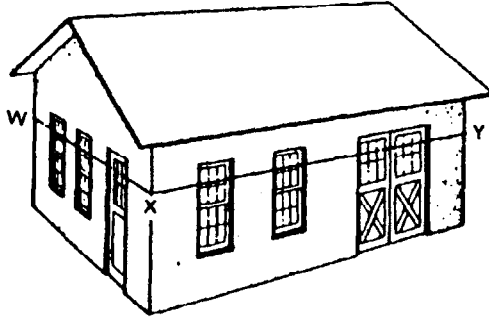

PERSPECTIVE VIEW OF A  
TYPICAL T/O BUILDING SHOWING  
CUTTING PLANE WXY

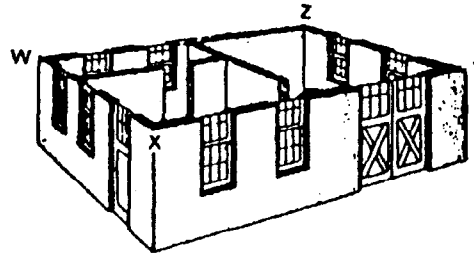

PREVIOUS PERSPECTIVE VIEW AT  
CUTTING PLANE WXYZ,  
TOP REMOVED

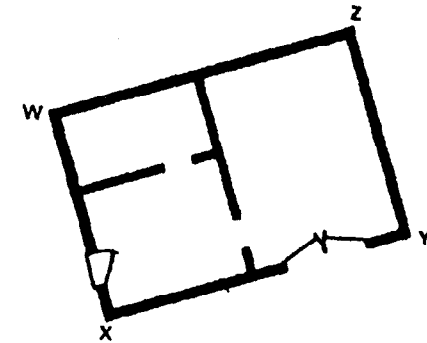

DEVELOPED FLOOR PLAN  
WXYZ

PLAN DEVELOPMENT — TYPICAL T.O. BUILDING

2

Figure F-4. Isometric views

possibly a roof plan view), giving the impression that the structure is being viewed from a corner.

*c. Floor Plans.* Floor plans are derived by passing an imaginary horizontal plane through the building at some given point (see figure F-5). The plan shows the horizontal relationship between building components. Horizontal dimensions appear in plan views, such as a site or floor plan. Dimension strings on the plan show overall dimensions, major breaks in the structure, and the placement of openings such as doors, windows, and louvers. Frequently, plumbing or electrical layouts are superimposed on the plan to show where pipes, fixtures, or conduits should be placed.

*d. Sections.* Sectional drawings (see figure F-6) show how a structure looks when it is cut by an imaginary vertical plane. The structure is usually drawn to large scale and shows details of a particular construction feature that cannot be explained by plans and elevations alone. The sectional drawing provides information about dimensions, materials, fastening and support systems, and concealed features. Wall sections are usually of greatest interest to builders, since those sections extend from the foundation up through the roof and show the construction of the wall and its relationship to floor and roof systems. Sections are keyed to the plan from which they were taken and are indicated on the plan by a section symbol.

*e. Details.*

(1) *General.* Details (see figure F-7) are large-scale drawings of features that either do not appear or are too small on plans, elevations, and sections. Details are usually keyed by a coding system to the drawing from which they were taken.

(2) *Wood Framing Details and Typical Theater Construction.* Structural framing, whether wood or steel, is the skeleton that carries dead loads (those contributed by the structure itself) and live loads (those contributed by occupants, equipment, wind, snow, etc.) to the foundation and then into the earth. Typical theater construction (see figures F-8, F-9, and F-10) uses standard lumber components, such as studs, joists, and plywood sheathing. Construction is conventional; however, because of limited design life, safety and durability factors are not as stringent as for civilian construction. Foundations are either concrete or expedient wood footings, depending on factors such as loading conditions, availability, engineer effort, etc. AFCS working drawings for theater buildings usually show details of all framing. Light wood framing is used in barracks, bathhouses, administration buildings, light shop buildings, hospital buildings, and similar types of structures. Heavy wood framing with lumber members of at least 6 inches (timber construction) is used in heavy roof trusses, timber trestle bridges, and wharves. The major difference between light and heavy framing is the size of the timber and the types of fasteners used.

### F-3. SYMBOLS ON DRAWINGS

Graphic symbols on construction drawings show the type and location of doors and windows, lighting and plumbing fixtures, wall partitions, and other construction information. Conventional symbols represent the types of construction materials to be used. The symbol selected normally resembles the actual material. For example, grain lines indicate wood, small dots and a triangle indicate concrete, etc.



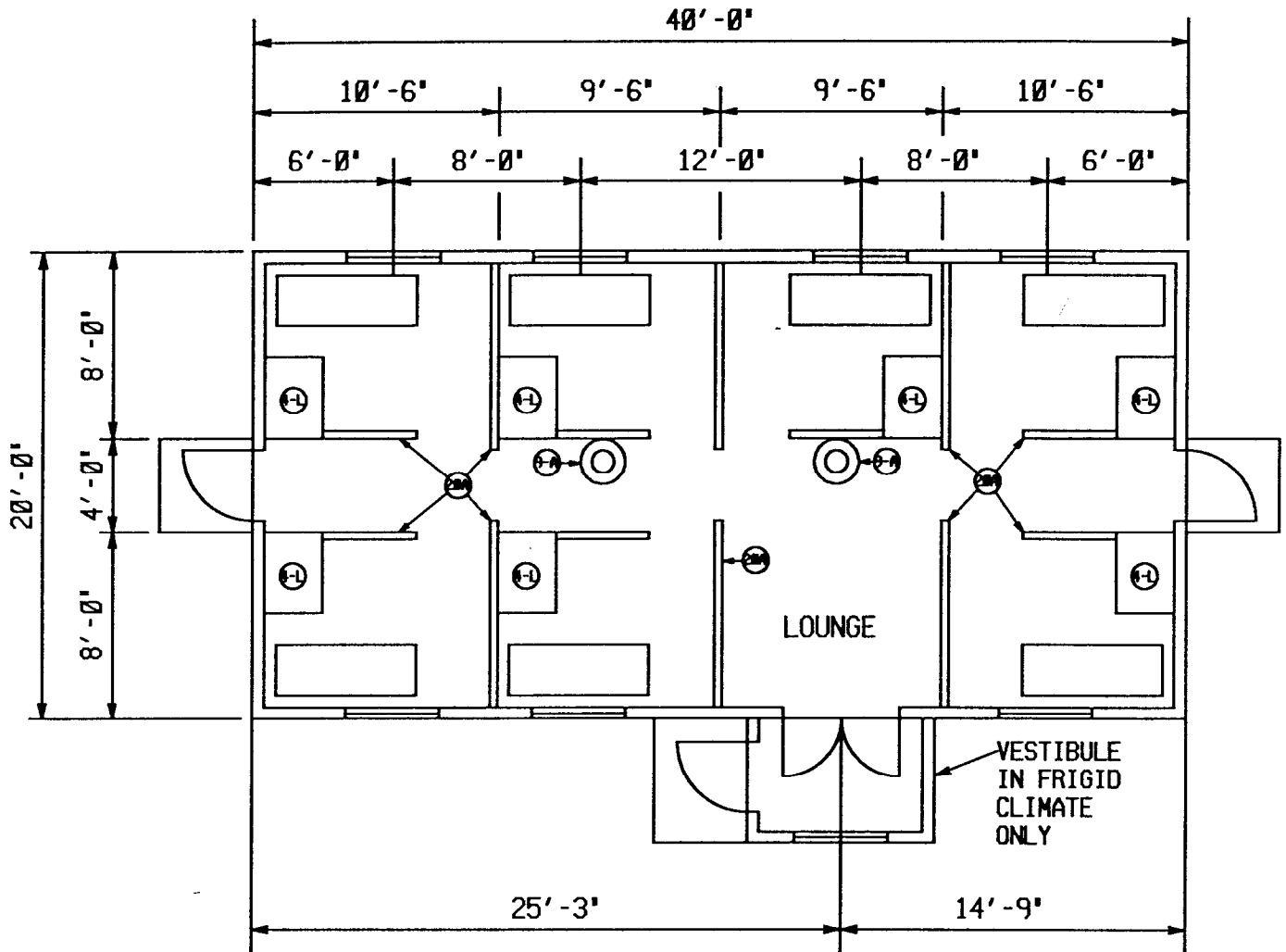

OFFICERS HOUSING FLOOR PLAN

Figure F-5. Typical floor plan

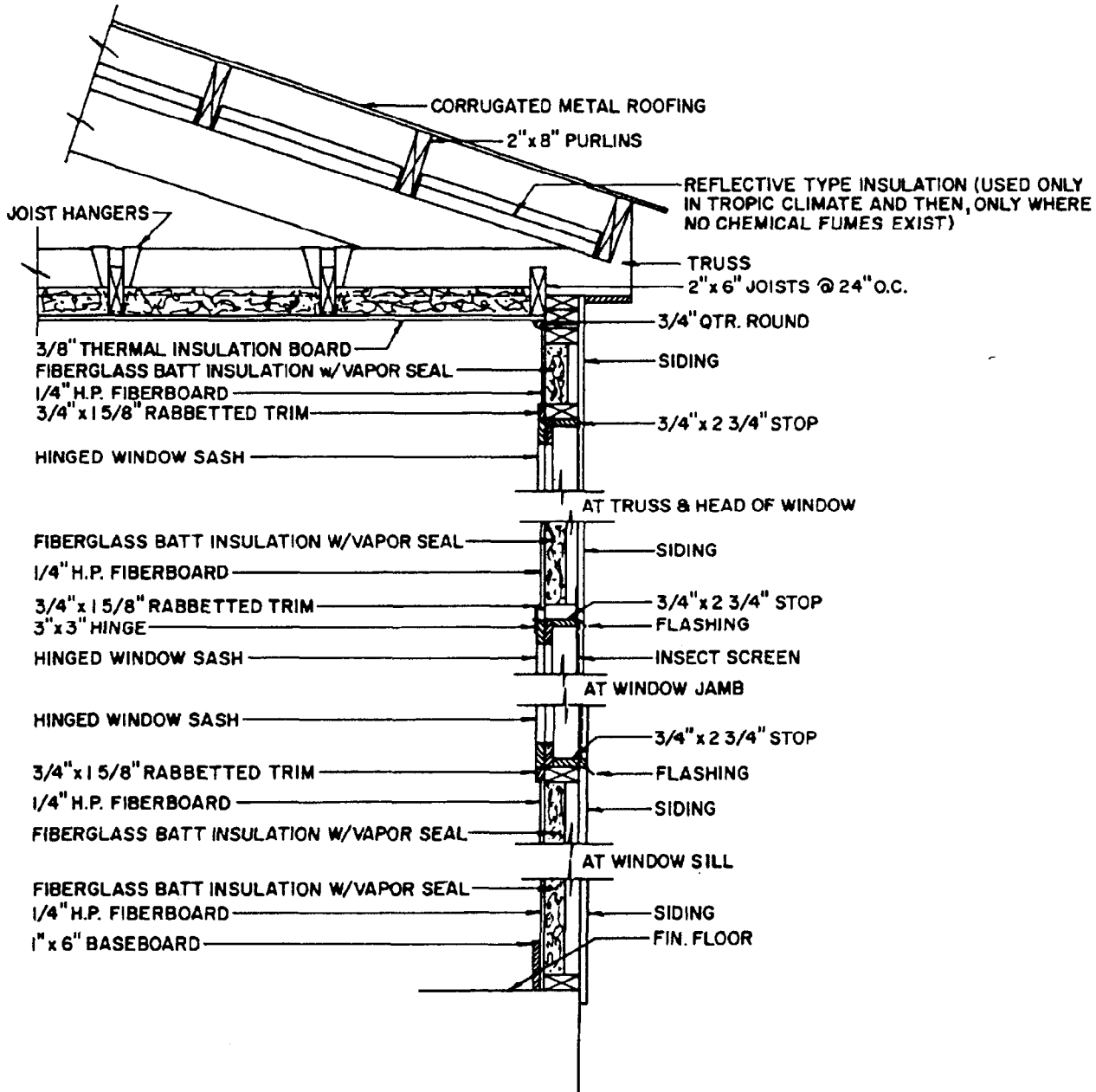
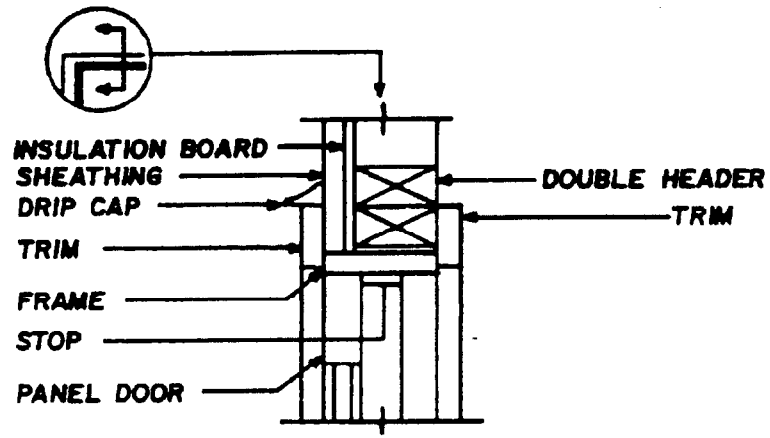
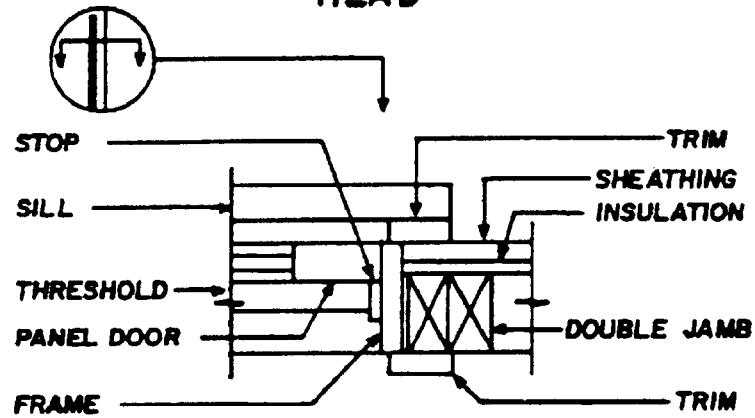

Figure F-6. Sectional drawings

### EXTERIOR DOOR DETAILS



HEAD



JAMB

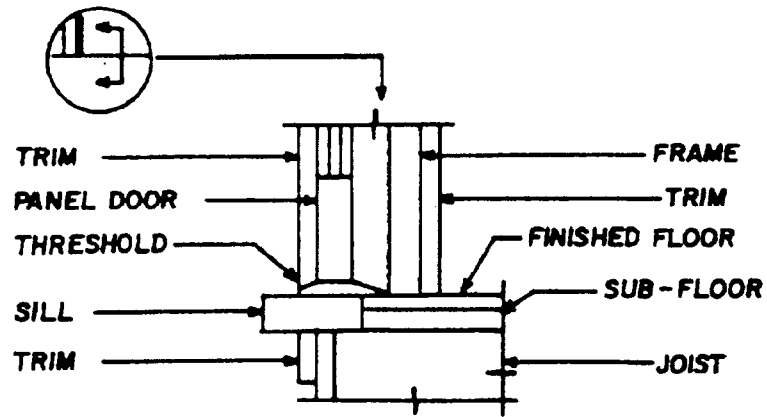

SILL

Figure F-7. Details

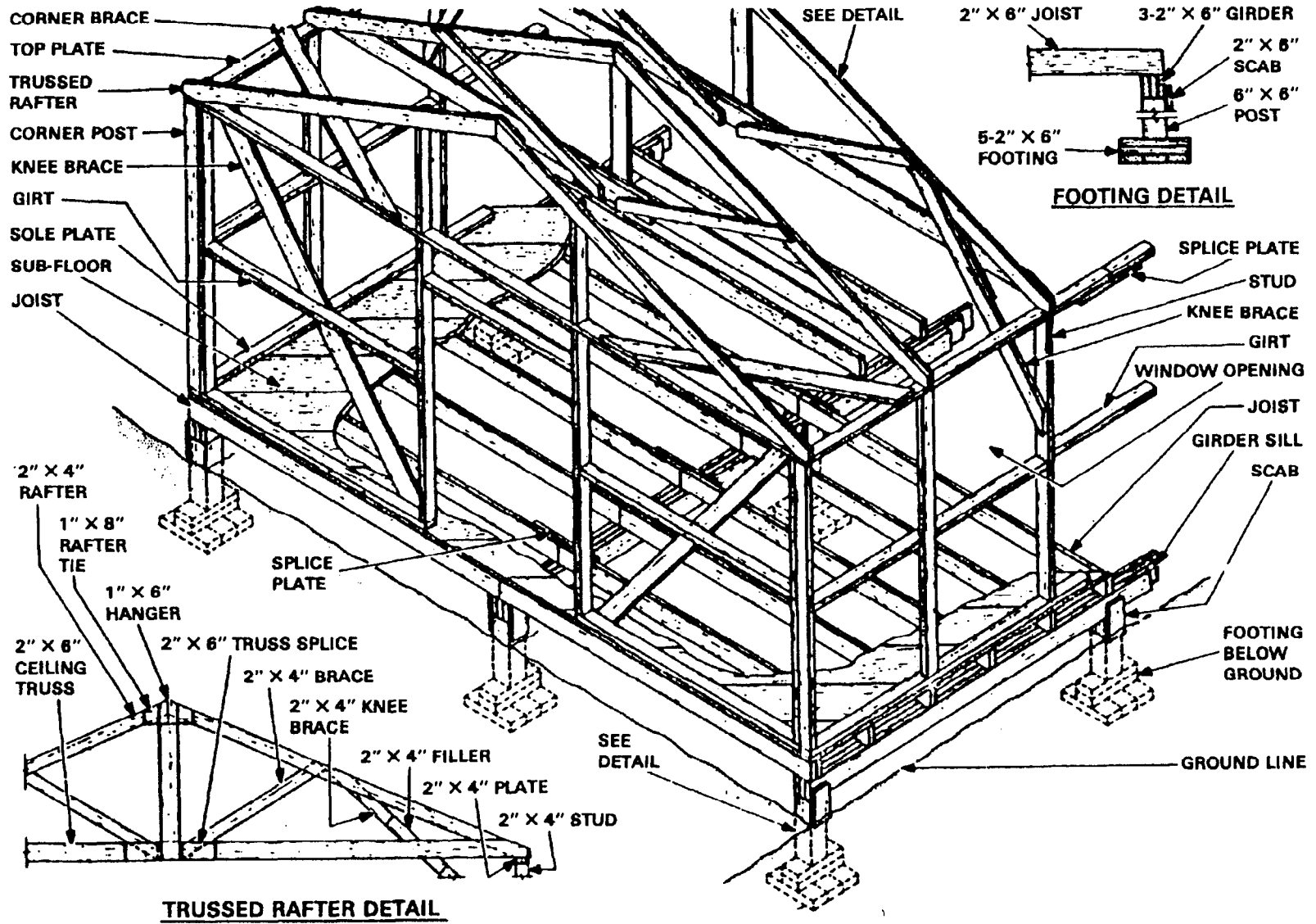
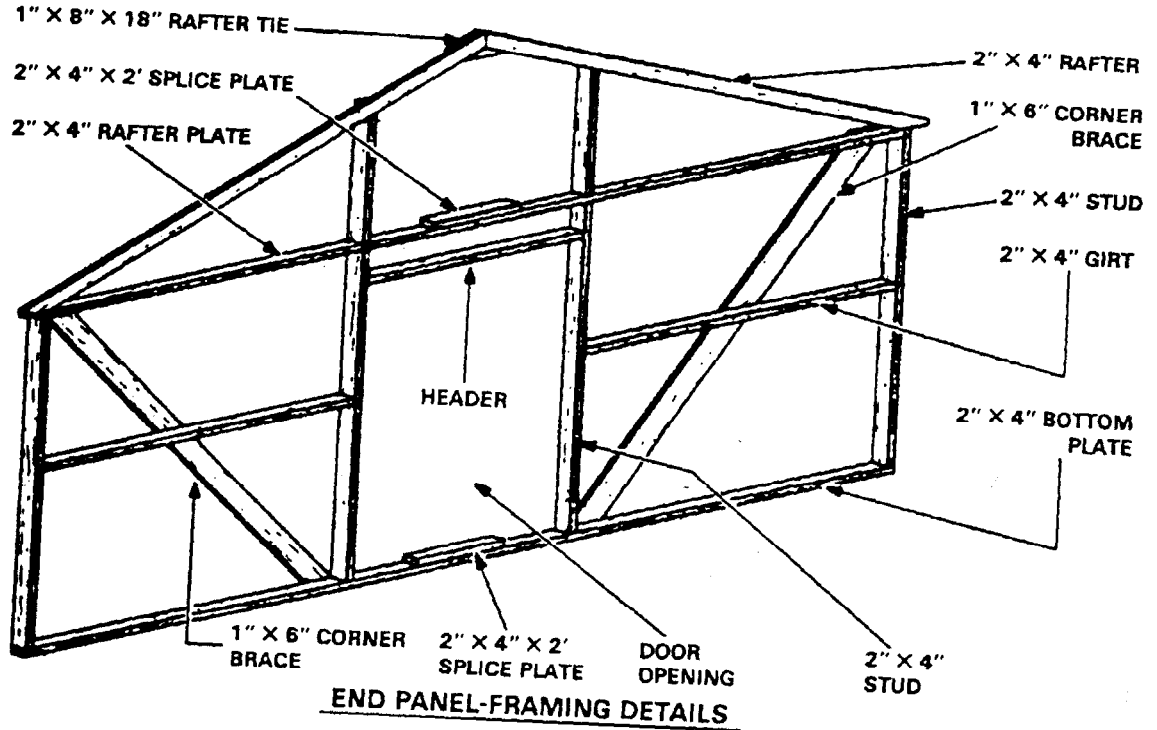
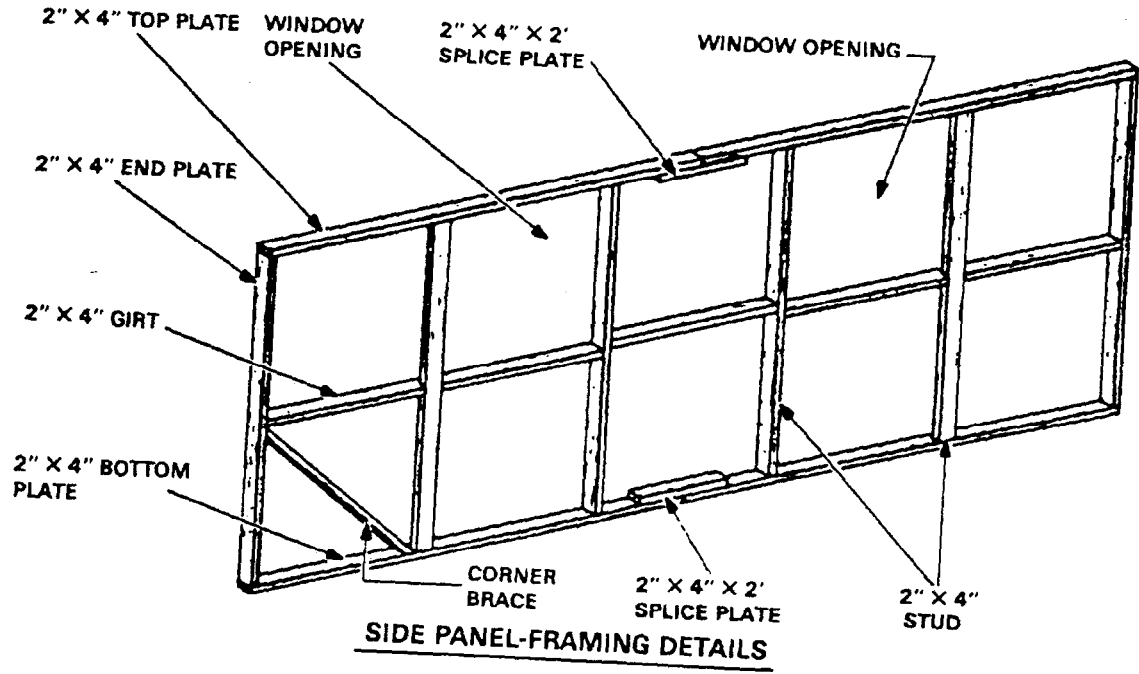

Figure F-8. Light framing details



①



②

Figure F-9. Typical wall panels-framing details

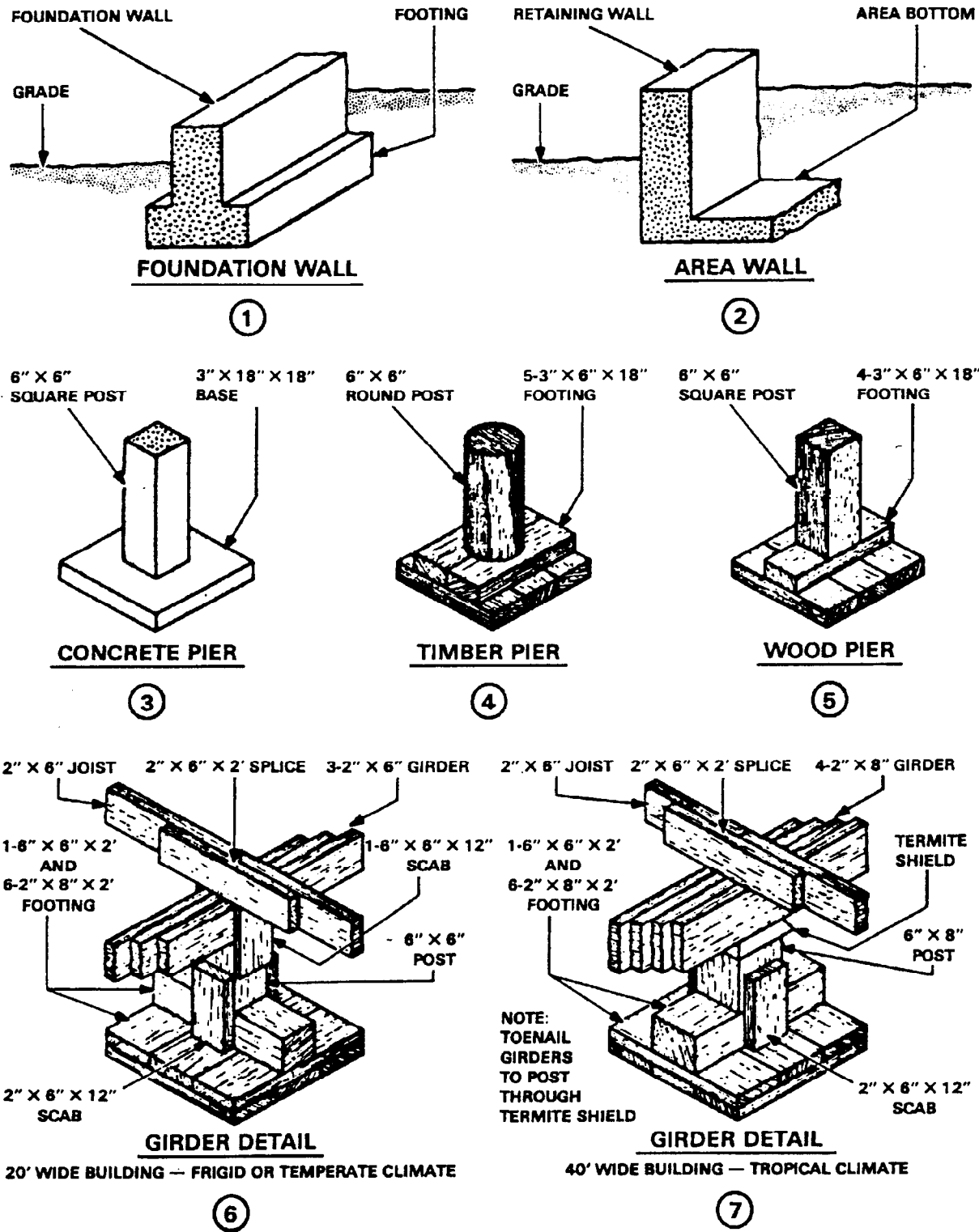

Figure F-10. Typical foundation and footing details

## APPENDIX G

### CPM NETWORK

#### G-1. USING CPM

The first step in using CPM is to determine the tasks required to complete the project as outlined in the directive. The next step is to ask the three following questions about each task:

- a. *Precedence.* What tasks must be finished before this task begins?
- b. *Concurrence.* What tasks may either start or finish at the same time that this task does?
- c. *Succession.* What tasks cannot begin until this task is finished?

#### G-2. CPM SYMBOLS

##### a. Activity Arrows and Event Nodes.

(1) *Arrows.* An arrow represents each activity (that is, any time-consuming part of the project); the arrow's tail and head represent an activity's start and finish, respectively. An arrow's length or angular direction is not related to how much time the activity takes; that is, the arrow is not time scaled. The way that the arrows are interconnected indicates which activity precedes or follows another.

(2) *Event Nodes.* A circle, which is called an event node, represents the start or finish of an activity. Numbers in the event node identify activities in the diagram. The rule for numbering events is that the number at the head of the arrow must be larger than the number at the tail. (For digital computer use, the arrow's tail could be designated "i" and its head "j." Each activity is then assigned a unique i-j designation.) In figure G-1, the activity may be called either "pour concrete" or "activity 5-8."

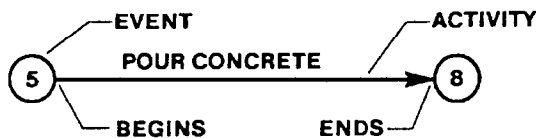

Figure G-1. Event numbers

b. *"I-J" Numbering.* The i-j numbering convention can eliminate certain problems in CPM construction, such as

a circular logic error. Figure G-2 shows a typical circular logic error. The number of the event at the head of activity G must be greater than 15; however, the number at the tail of activity H must be less than 10. Since the event numbering rule cannot be followed here, the i-j convention would prevent the error.

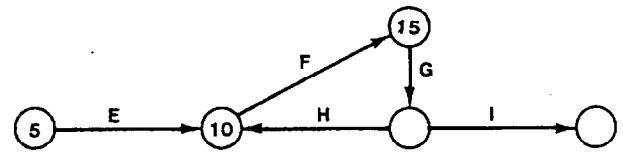

Figure G-2. Circular logic error

c. *CPM Logic.* The logic behind CPM networks is that an activity (arrow) leaving an event (circle) cannot begin until all activities heading into that event are completed. Figure G-3 shows that activity B cannot begin until activity A is completed. It also indicates that activity G cannot start until activities C and D are finished and that neither activity D nor H can start until activity I is completed. Activities C and D are concurrent because they can end at the same event, and activities D and H can start at the same time.

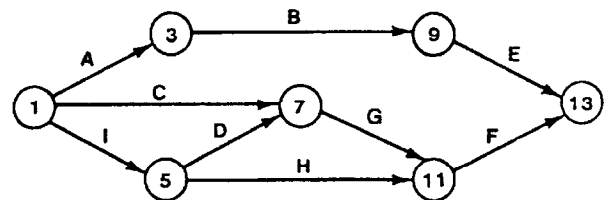

Figure G-3. CPM network

##### d. "Dummy" Arrow.

(1) A "dummy" arrow is another CPM device that shows a sequence relationship but does not represent any activity. A brief example can demonstrate the use of the dummy arrow: Suppose that an engineer unit is to

construct a gravel road and pour concrete nearby. Assume that the same gravel and rock should be used for both the road surface and the concrete. The CPM diagram might look like figure G-4.

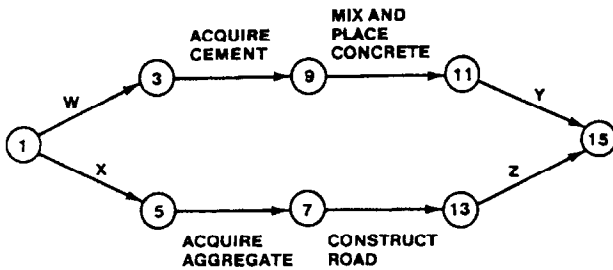

Figure G-4. Example CPM diagram

(2) As shown in figure G-4, the road depends on having the aggregate, and the concrete mixing depends on having the cement; however, mixing the concrete also requires having the aggregate. Therefore, the concrete depends on both the cement and the aggregate. The figure also shows that constructing the road depends on acquiring the cement, even though cement is not required for its construction. According to the diagram, road construction would be constrained unnecessarily.

(3) The way out of the problem is to draw a dashed arrow from the end of the aggregate activity to the beginning of the concrete activity. The dashed arrow simply shows a sequence relationship (concrete depends on aggregate) that has no name and does not represent any part of the project. Thus, the dashed arrow is called a "dummy" activity, as shown in figure G-5.

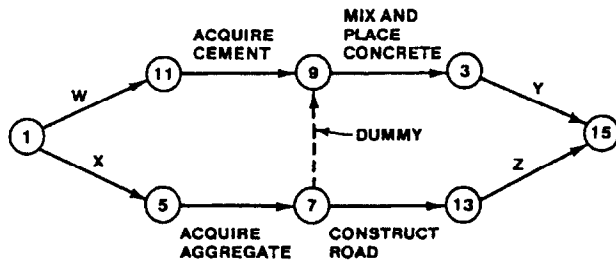

Figure G-5. "Dummy" activity

e. *Event Times.* The next step in the CPM process is to calculate the earliest and latest times when events can occur. An event occurs immediately after all activities going into it are completed; thus, succeeding activities cannot start until the event has occurred. Event times represent the end of the time period needed to complete an activity; therefore, an event time of 5 would mean the end of the fifth day (or hour, week, etc.). Several definitions related to various event times used in the CPM process are listed in paragraphs (1) through (8) below:

(1) *Duration (D).* The shortest time, expressed in any desired unit, required to perform an activity.

(2) *Earliest Start (ES).* The earliest time that an activity can be started.

(3) *Earliest Finish (EF).* The earliest time an activity can be finished:

$$EF = ES + D$$

(4) *Latest Start (LS).* The latest time an activity can be started without delaying completion of the project:

$$LS = LF - D$$

(5) *Latest finish (LF).* The latest time that an activity can be finished without delaying completion of the project:

$$LF = LS + D$$

(6) *Total Float (TF).* The amount of time that the start or finish of any given activity can be delayed without delaying completion of the project:

$$TF = LF - EF \text{ or } LS - ES$$

(7) *Free Float (FF).* The amount of time that the finishing of an activity can be delayed without delaying the earliest starting time for a subsequent activity:

$$FF = ES \text{ (following activity)} - EF \text{ (of this activity)}.$$

(8) *Critical Path.* The critical path is the series of interconnected activities through the network in which each activity has zero float time. The critical path determines the minimum time required to complete a project.

f. *Computer Generated CPM.* A computer program that uses the CPM technique to facilitate rapid scheduling of AFCS military construction projects in the TO has been developed. The program computes the most qualified engineer construction unit(s) and the number of work days needed for construction.



Table G-1. Construction activities for CPM example

ACTIVITY	DESCRIPTION
Site preparation	Clear site, compact subbase, and lay out building and parking area.
Install forms	Excavate footings; install reinforcing and forms.
Under-slab utilities	Install electrical conduit and water, gas, and sewer pipes.
Place concrete	Place, finish, and cure concrete slab; remove forms.
Place concrete block	Place concrete block walls, reinforcing bars, anchor bolts, and grout.
Install trusses	Install top plate, erect trusses, block, and brace.
Precut frame walls	Cut plates, studs, trimmers, headers, and stock on site.
Frame	Frame interior walls in place.
Roofing	Install plywood decking, roof gutters, downspouts, and asphalt shingles.
Utilities	Install electrical conduit, wiring, plumbing pipes, and heating ducts.
Finish interior	Install doors, windows, shelves, trim, counter, flooring, lights, outlets, switches, latrine fixtures, heater and hot water tank, wallboard, and paint.
Walk and steps	Lay out, form, brace, place concrete, finish concrete, and remove forms.
Parking area	Install culvert, place base course, and pave.

### G-3. CPM EXAMPLE

*a. Problem Description.* The following CPM example considers the construction of a typical TO building: A 20-foot by 40-foot office building is to be constructed in an ammunition storage area. It will use concrete block with slab-on-grade wood-frame wall partitions and wood roof trusses. A breakdown of the construction activities is listed in table G-1.

*b. Determining Activity Duration.* After the construction activities have been determined for the CPM diagram, each activity's duration must be determined. Activity duration (in terms of days) is a function of the engineer unit work capability to be employed and the size of the jobs to be done. TM 5-301 lists the total man-hours required for a particular job. To determine durations, refer to the TOE and apply experience gained from previous construction. The three questions concerning precedence, concurrence, and succession for each activity are then asked (see paragraph G-1). The results have been used to construct the CPM diagram (figure

G-6). The numerals below the activities are the durations (in days) allotted for completing those activities.

*c. Early Event Time (EET).* Also shown on the CPM diagram (in the square above each event number) are the early event times. They are used to determine the earliest time that each event in the path can be started. The early event time equals the longest of the paths coming into an event. Figure G-6 shows that the project will take an estimated 27 working days, or about 4 weeks.

*d. Late Event Time (LET).* The late event times are placed below each event number in the triangles. The late event time is the latest time that an event can occur and not delay the project beyond the earliest completion time; therefore, the late event time and the early event time for the ending event are the same. To find the other late event times, work backwards through the diagram against the arrows, subtracting activity durations from the late event time at the head of an arrow to get the late event time at the tail of the arrow (disregarding the early event times.) Where there is a choice of late event times,

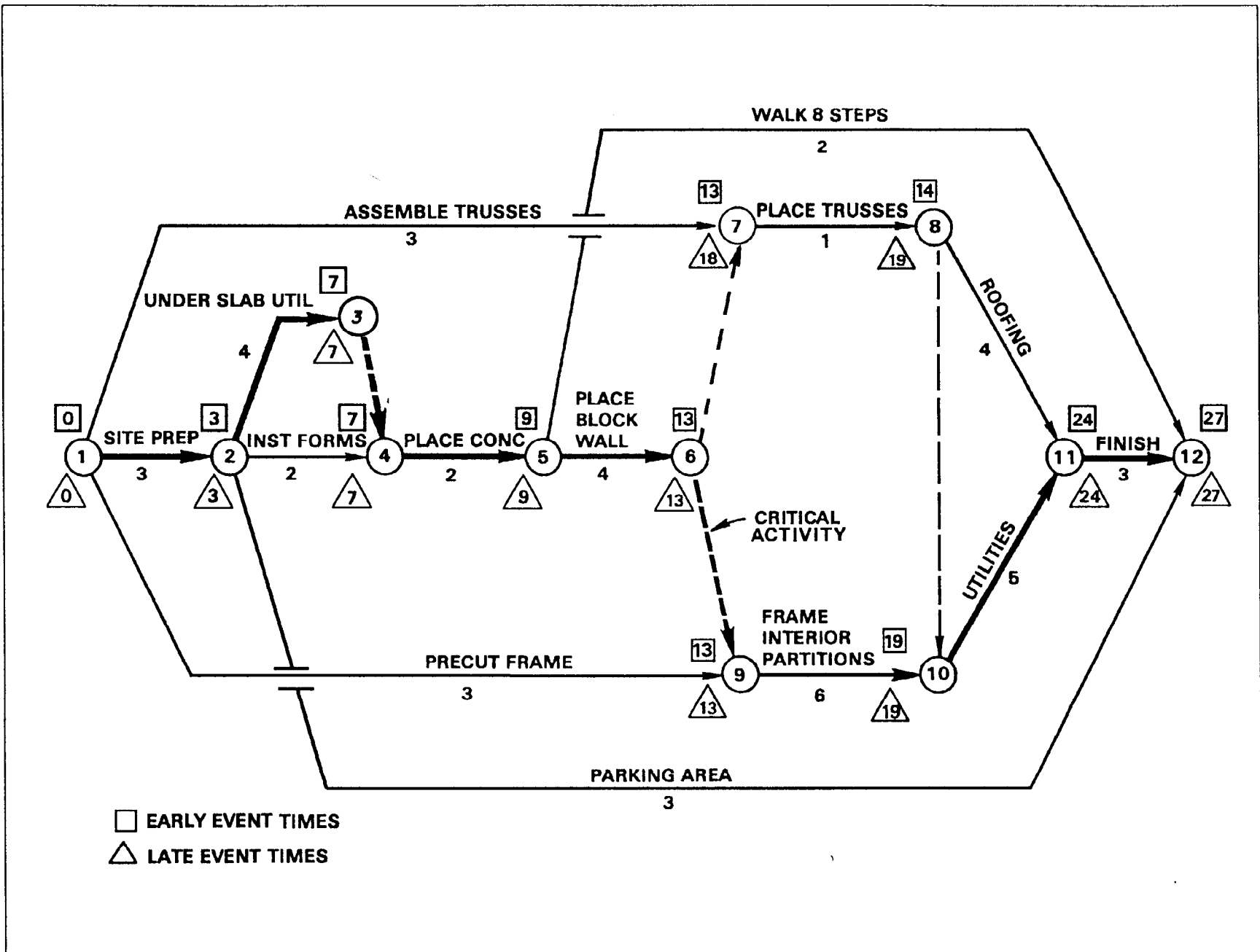

Figure G-6. CPM diagram for a typical office building

Table G-2. Tabulation of construction activities

Activity	Title	D	ES	EF	LS	LF	TF
1-2	Site preparation	3	0	3	0	3	0
1-7	Assemble trusses	3	0	3	15	18	15
1-9	Precut frame walls	3	0	3	10	13	10
2-3	Under-slab utilities	4	3	7	3	7	0
2-4	Install forms	2	3	5	5	7	2
2-12	Parking area	3	3	6	24	27	21
4-5	Place concrete	2	7	9	7	9	0
5-6	Place concrete block	4	9	13	9	13	0
5-12	Walk and steps	2	9	11	25	27	16
7-8	Install trusses	1	13	14	18	19	5
8-11	Roofing	4	14	18	20	24	6
9-10	Frame walls	6	13	19	13	19	0
10-11	Utilities	5	19	24	19	24	0
11-12	Finish	3	24	27	24	27	0

choosing the smallest one will ensure that the project is not delayed. If the last late event time calculated is not zero, a mistake has been made. (See figure G-6.)

*e. Critical Activity.* A critical activity is an activity which if delayed would delay the entire project. In a critical activity, the earliest and latest event times at the tail of the arrow are equal, and the earliest and latest event times at the head of the arrow are equal. For activities that pass those criteria, the EET (or LET) at the head minus the EET (or LET) at the tail is equal to the duration of the activity:

$$D = EET_{\text{head}} - EET_{\text{tail}} \text{ or } D = LET_{\text{head}} - LET_{\text{tail}}$$

*f. Tabulation of Construction Activities.* Perhaps the easiest way to get information from the CPM diagram is to construct a table that shows the activity number and title, activity duration, earliest start, and latest finish. (See table G-2.) Adding duration to the ES column and subtracting it from the LF column yields EF and LS, respectively. TF then is simply LS minus ES (or LF minus EF). All activities with zero TF are on the critical path. In table G-2, an ES of 0 means that work starts at the beginning of time period 1, and an LF of 3 means work ends at the end of time period 3. As shown in figure G-6, the shortest time in which the project can be completed is 27 days (see column EF of activity 11-12).

## GLOSSARY

### Section I: Abbreviations and Acronyms

AFCS ..... Army Facilities Components System  
 AMC ..... Army Materiel Command  
 AR ..... Army regulation  
 BDP ..... Base Development Plan  
 B/O ..... back order  
 BOM ..... bills of materials  
 CESP ..... Civil Engineer Support Planning  
 CM ..... commodity manager  
 CO MO ..... company month  
 CONUS ..... continental United States  
 CPM ..... Critical Path Method  
 CTA ..... Common Table of Allowances  
 D ..... duration  
 DA ..... Department of the Army  
 DLA ..... Defense Logistics Agency  
 DOD ..... Department of Defense  
 EET ..... early event time  
 EF ..... earliest finish  
 ES ..... earliest start  
 FF ..... free float  
 FM ..... field manual  
 GSA ..... General Services Administration  
 HV ..... heavy  
 INT ..... initial standard of construction (up to  
                   6 months)  
 LET ..... late event time  
 LF ..... latest finish  
 LS ..... latest start  
 LSSA ..... Logistics Systems Support Activity  
 MACOM ..... Major Army command  
 ME ..... medium  
 MH ..... man-hour

MILSTRIP ..... Military Standard Requisitioning and  
                   Issue Procedure  
 MILVAN ..... military-owned demountable container  
 MO ..... month  
 MRO ..... material release orders  
 MT ..... measured ton (40 cubic feet per  
                   measured ton)  
 NICP ..... National Inventory Control Point  
 NSN ..... National Stock Number (replaces FSN)  
 OPNS ..... operations  
 PECS ..... prepackaged expendable contingency  
                   supplies  
 POL ..... petroleum, oil, lubricant  
 SIMF ..... Stock Item Master File  
 SP ..... self-propelled  
 SRC ..... standard requirement code  
 ST ..... short ton (2,000 pounds)  
 TACAPS ..... Theater Army Construction Automated  
                   Planning System  
 TF ..... total float  
 TM ..... technical manual  
 TO ..... theater of operations  
 TOE ..... table of organization and equipment  
 TPR ..... temporary standard of construction  
                   (up to 24 months)  
 TRADOC ..... U.S. Army Training and Doctrine  
                   Command  
 TROSCOM ... U.S. Army Troop Support Command  
 USACE ..... U.S. Army Corps of Engineers  
 USAEDH ..... U.S. Army Engineer Division, Huntsville  
 UTC ..... unit type code

### Section II: Abbreviations for Construction Materials

The following are abbreviations for units of issue in TM 5-303 (BOM) and in the SIMF. They are as shown in the Federal Supply Catalog, C1 (Army).

AM ..... ampoule  
 AT ..... assortment  
 AY ..... assembly  
 BA ..... ball  
 BD ..... bundle  
 BE ..... bale  
 BF ..... board foot  
 BG ..... bag  
 BK ..... book  
 BL ..... barrel  
 BO ..... bolt  
 BR ..... bar  
 BT ..... bottle  
 BX ..... box  
 CA ..... cartridge  
 CB ..... carboy  
 CD ..... cubic yard  
 CE ..... cone  
 CF ..... cubic foot  
 CK ..... cake  
 CL ..... coil  
 CN ..... can  
 CO ..... container  
 CY ..... cylinder  
 CZ ..... cubic Meter  
 DR ..... drum  
 DZ ..... dozen  
 EA ..... each  
 FT ..... foot  
 GL ..... gallon  
 GP ..... group  
 GR ..... gross  
 HD ..... hundred  
 HK ..... hank  
 JR ..... jar  
 KT ..... kit

LB ..... pound  
 LG ..... length  
 LI ..... liter  
 MC ..... thousand  
 ME ..... meal  
 MR ..... meter  
 MX ..... thousand  
 OT ..... outfit  
 OZ ..... ounce  
 PD ..... pad  
 PG ..... package  
 PM ..... plate  
 PR ..... pair  
 PT ..... pint  
 PZ ..... packet  
 QT ..... quart  
 RA ..... ration  
 RL ..... reel  
 RM ..... ream  
 RO ..... roll  
 SD ..... skid  
 SE ..... set  
 SF ..... square foot  
 SH ..... sheet  
 SK ..... skein  
 SL ..... spool  
 SO ..... shot  
 SP ..... strip  
 SY ..... square yard  
 SX ..... stick  
 TN ..... ton  
 TO ..... troy ounce  
 TU ..... tube  
 VI ..... vial  
 YD ..... yard

The proponent agency for this publication is the office of the Chief of Engineers, United States Army. Users are invited to send comments and suggested improvements on DA Form 2028 (Recommended Changes to Publications and Blank Forms) to HQDA (DAEN-ZCM), WASH, DC 20310-2600.

By Order of the Secretary of the Army,

CARL E. VUONO  
General, United States Army  
Chief of Staff

Official:

PATRICIA P. HICKERSON  
Colonel, United States Army  
The Adjutant General

Distribution:

Army: To be distributed in accordance with DA Form 12-34B, Requirements for Nonequipment Technical Manuals.